

Assembly Manual / Guide d'assemblage / Manual de ensamblaje / Montageanleitung

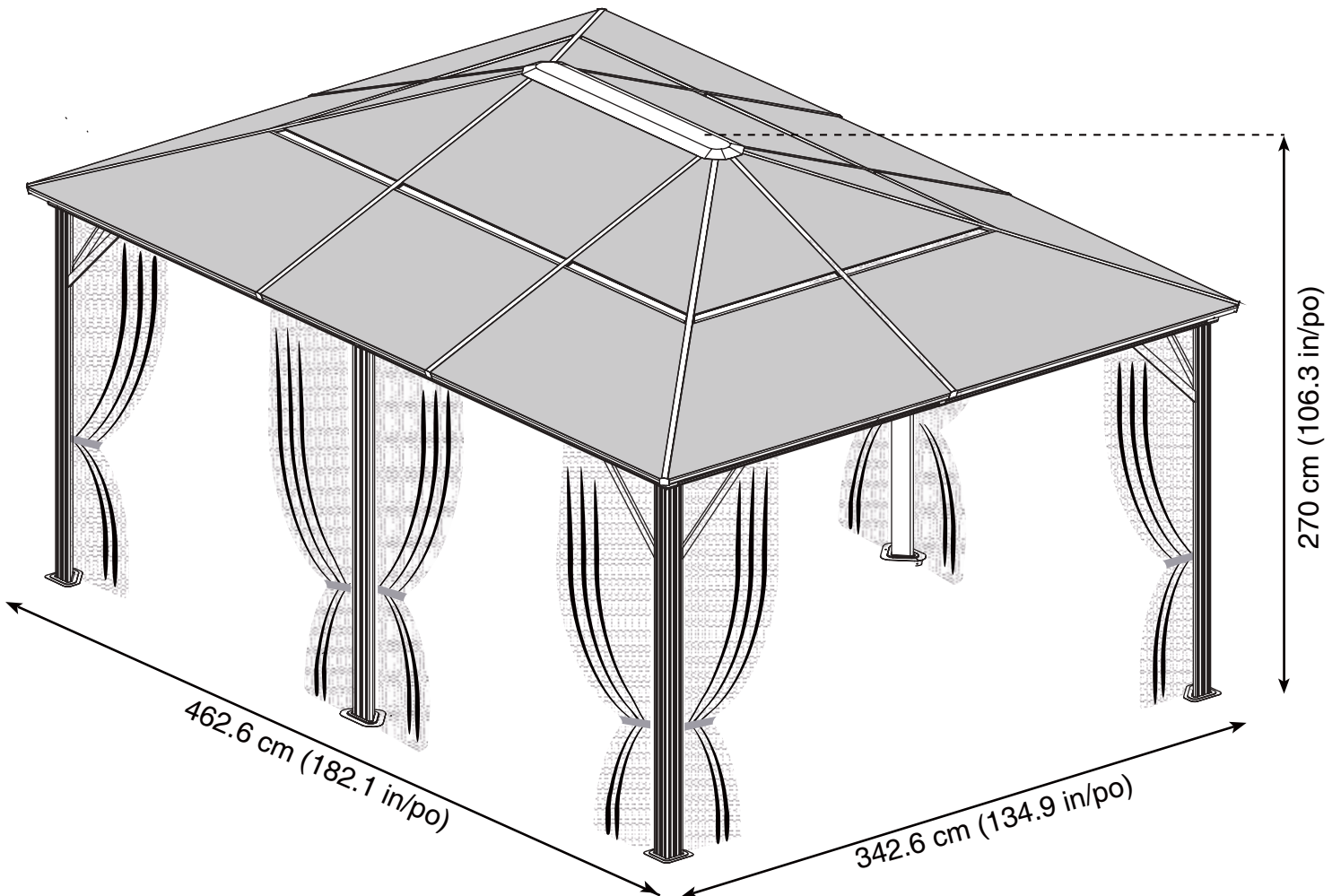

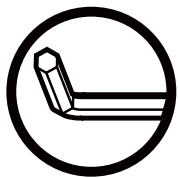

Use the hex keys in the box. / Utilisez les clés hexagonales fournies dans la boîte. / Utilice las llaves hexagonales en la caja. / Verwenden Sie die Sechskantschlüssel in der Box.

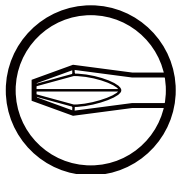

Please use a Phillips screwdriver. / Utilisez un tournevis de type Phillips / Por favor, use un destornillador Phillips. / Bitte verwenden Sie einen Kreuzschraubenzieher.



You may need to use a drill for this step. / Vous pouvez avoir besoin d'utiliser une perceuse pour cette étape. / Puede que tenga que utilizar un taladro para este paso. / Für diesen Schritt können Sie einen Bohrer verwenden.



Wearing protective gloves is recommended. / Le port de gants de protection est recommandé / El uso de guantes de protección se recomienda. / Das Tragen von Schutzhandschuhen wird empfohlen.



Two or more people are required at this stage. / Deux personnes ou plus sont nécessaires à cette étape. / Dos o más personas se requieren en esta etapa. / Für diesen Bauschritt sind 2 oder mehr Personen erforderlich.



Do not tighten screws all the way for now. / Ne pas visser fermement pour l'instant. / No atornille con firmeza por ahora. / Bitte die Schrauben zum jetzigen Zeitpunkt noch nicht fest anziehen.

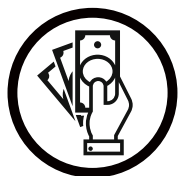

Sold separately. / Vendus séparément. / vendido en las opciones. / Optional erhältlich



Optional step / Étape optionnelle / Paso opcional / Optionaler Schritt

U X68(+6)

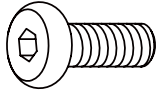

U1 X 52 (+5)

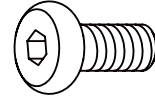

U2 X2 (+1)



V X 16 (+3)

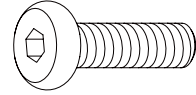

V1 X1 (+1)

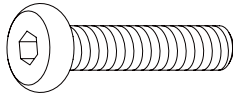

W X 16 (+2)

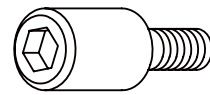

X X 10 (+2)

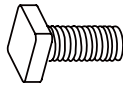

X1 X 30 (+6)



Y X 24 (+4)

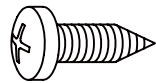

Y1 X 20 (+4)

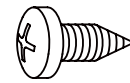

Z X1



Z1 X2

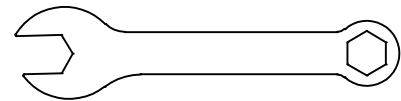



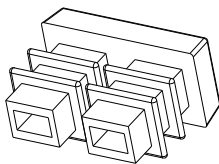





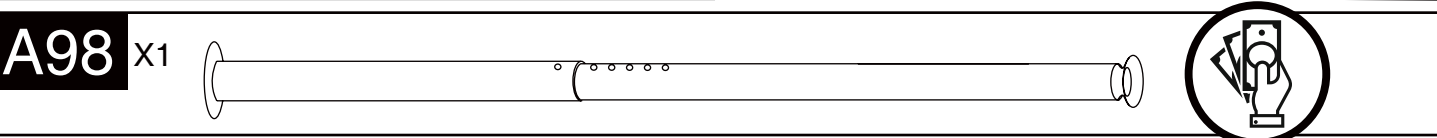
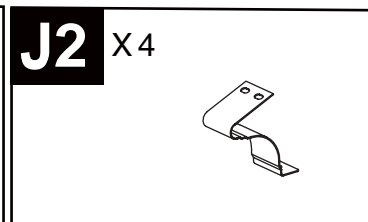
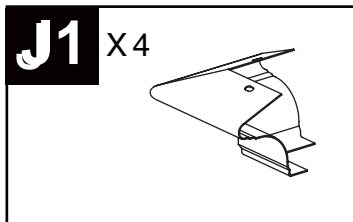
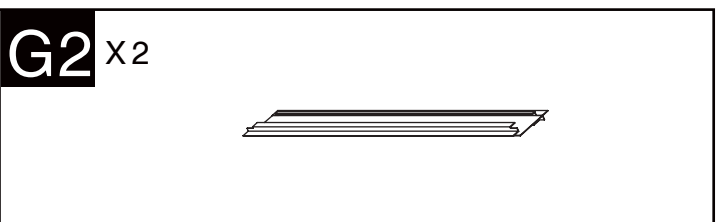
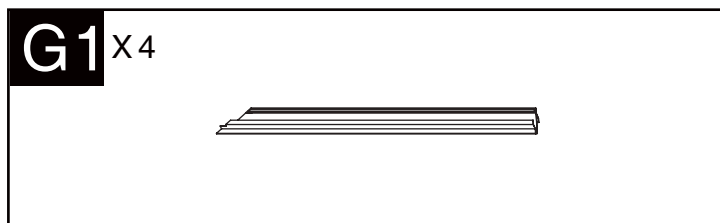
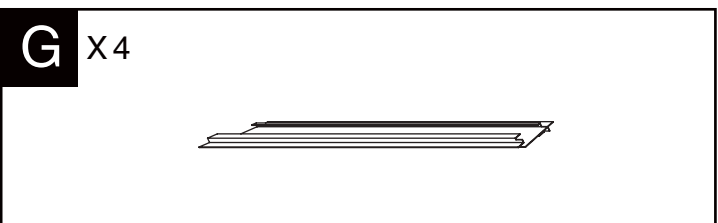
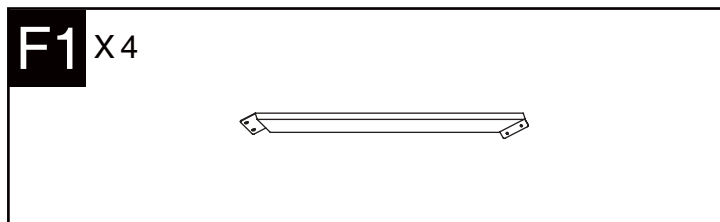
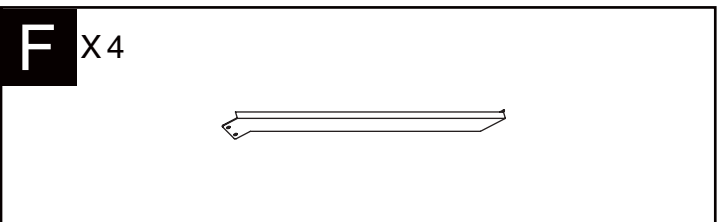
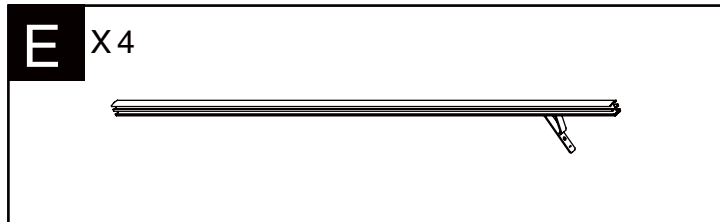
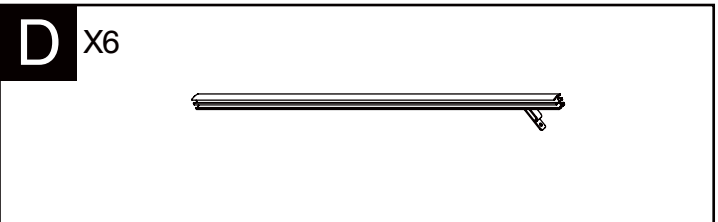
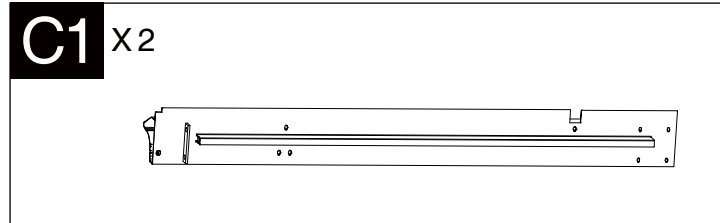
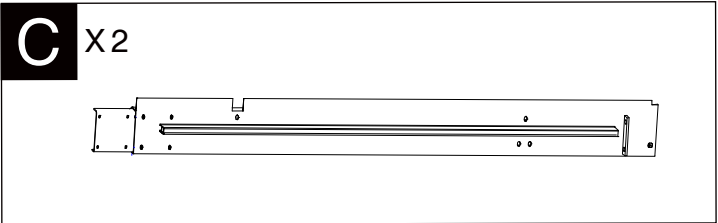
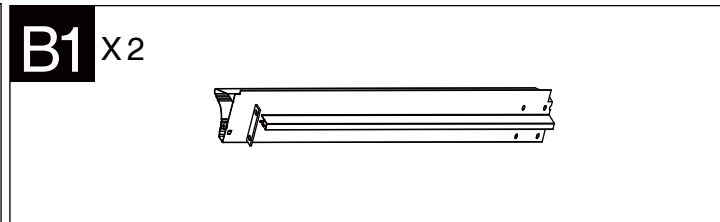
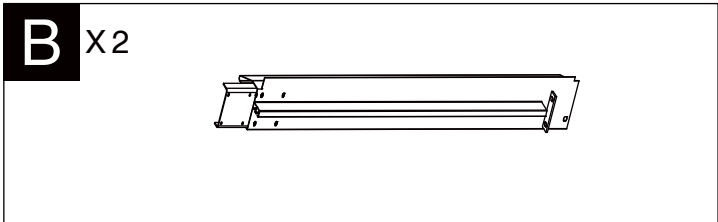
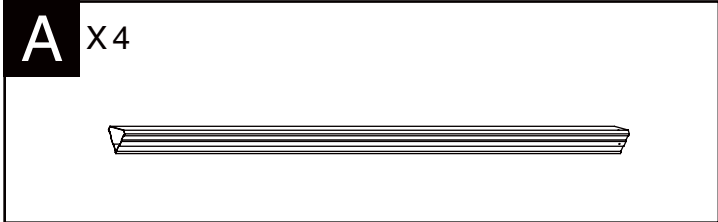







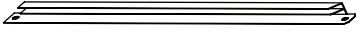
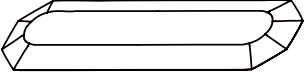
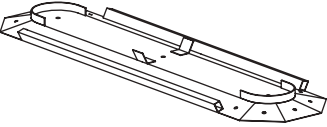
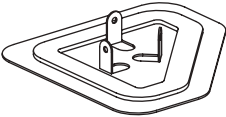
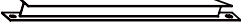

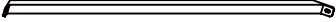
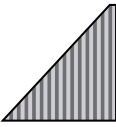
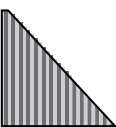
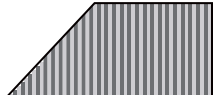
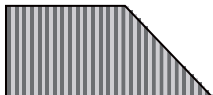

Z2 X4(+1)

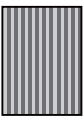

Z3 X8(+2)

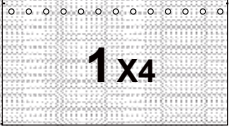
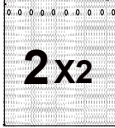



H X4 	H1 X4 	H2 X2 
I X4 	I1 X4 	I2 X2 
K X1 	K1 X1 	L X6 
N X4 	N1 X4 	
N2 X2 	O X4 	O1 X6 
Q X4 	Ma X4 	M1a X4 
Mb X4 	M1b X4 	
P X2 	P1 X2 	T X 68 (+2) Optional  
		T X 68 (+2) Optional  
Net  1x4  2x2 	Curtain  3x4  4x2 	

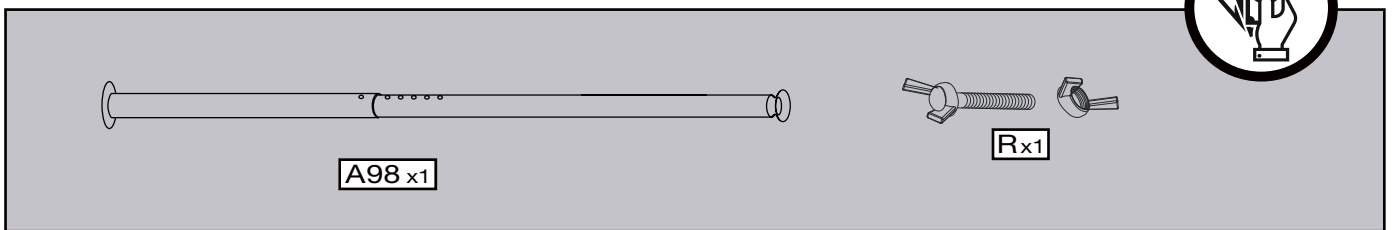
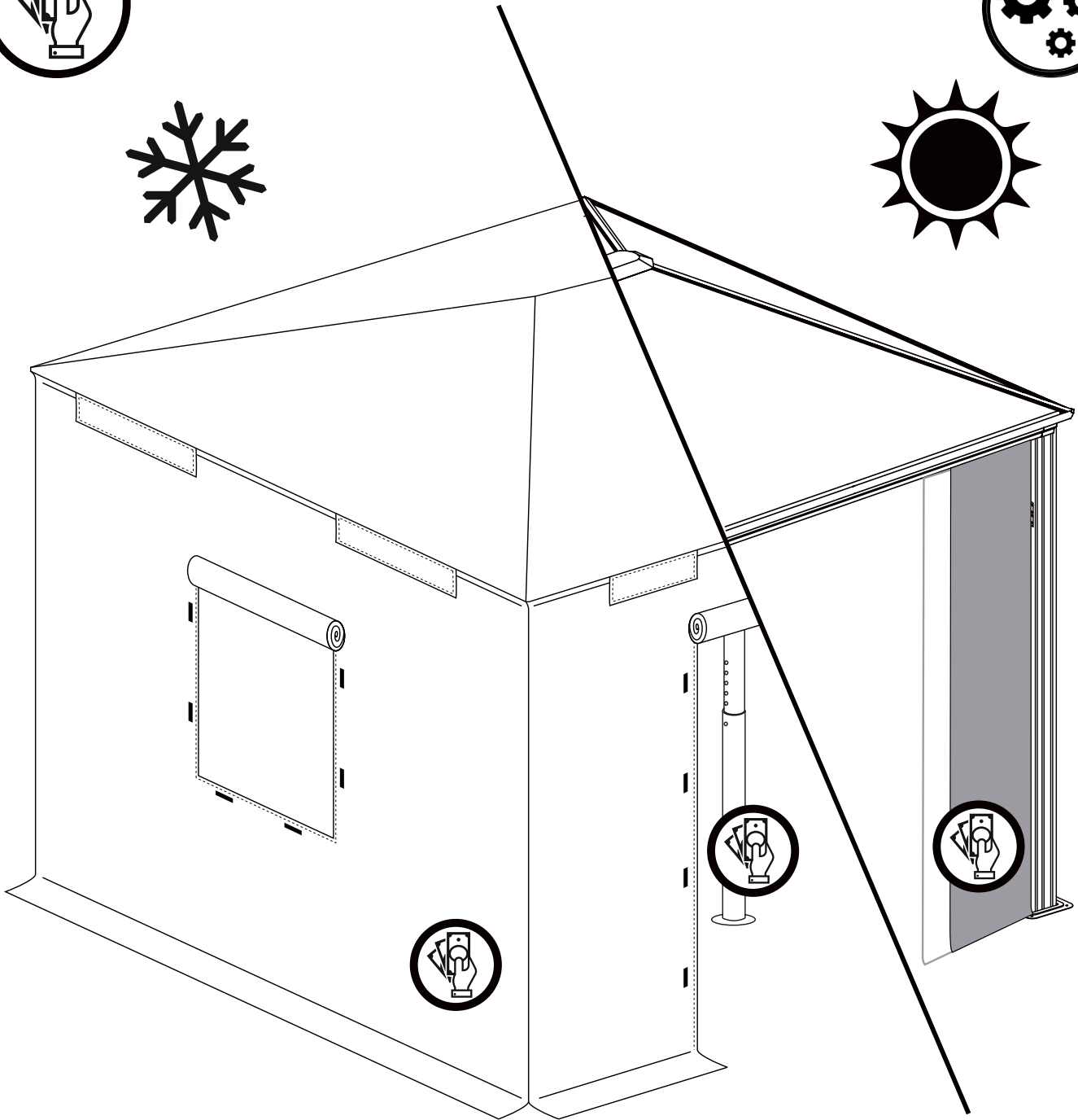
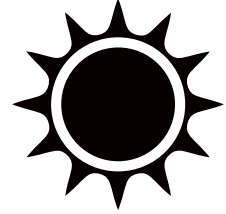
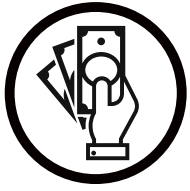

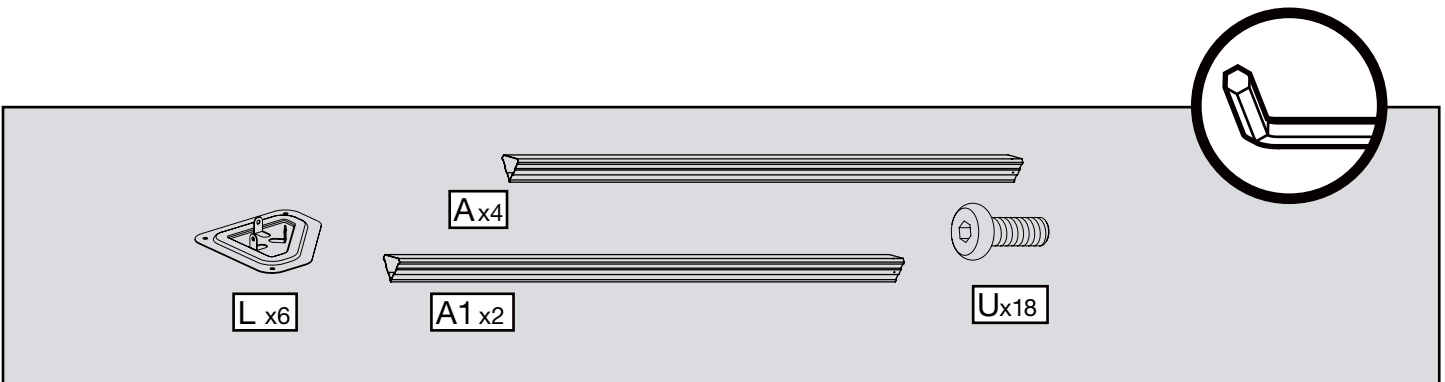
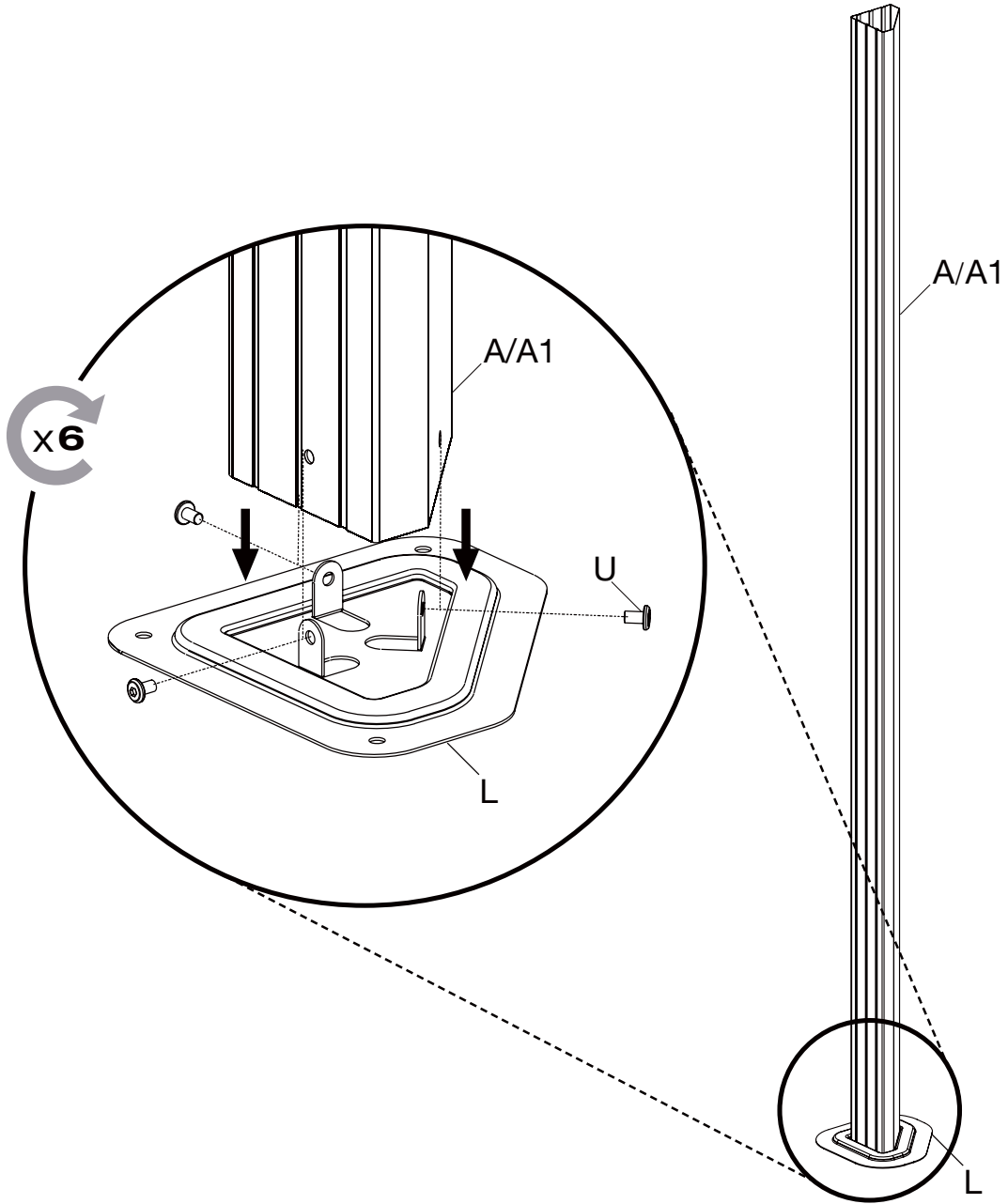

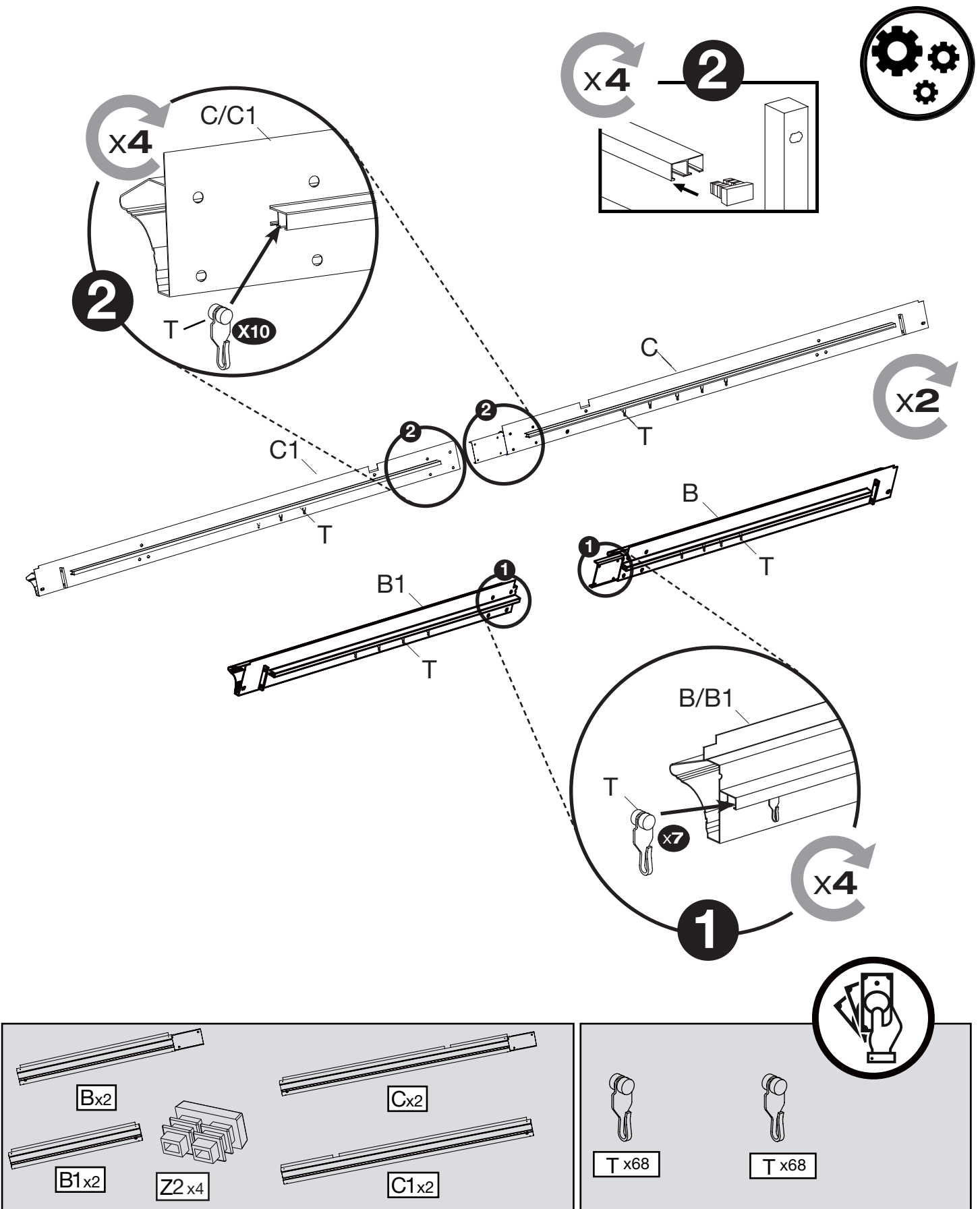

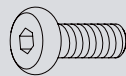
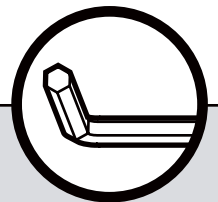
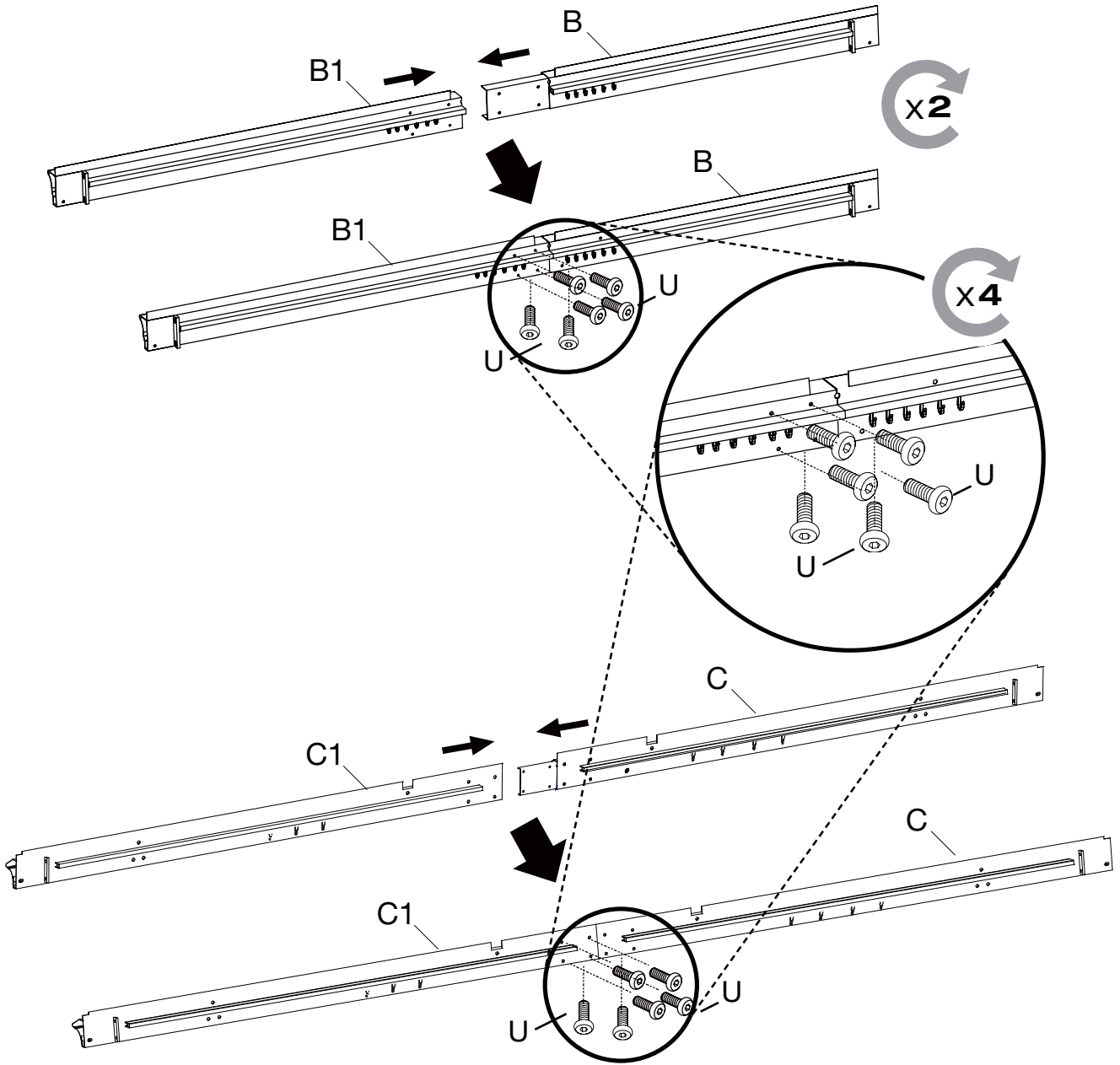

Ux24

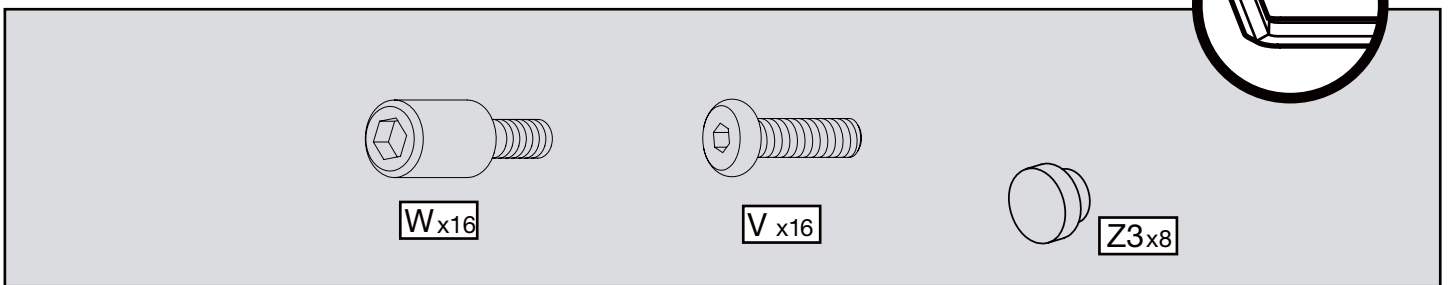
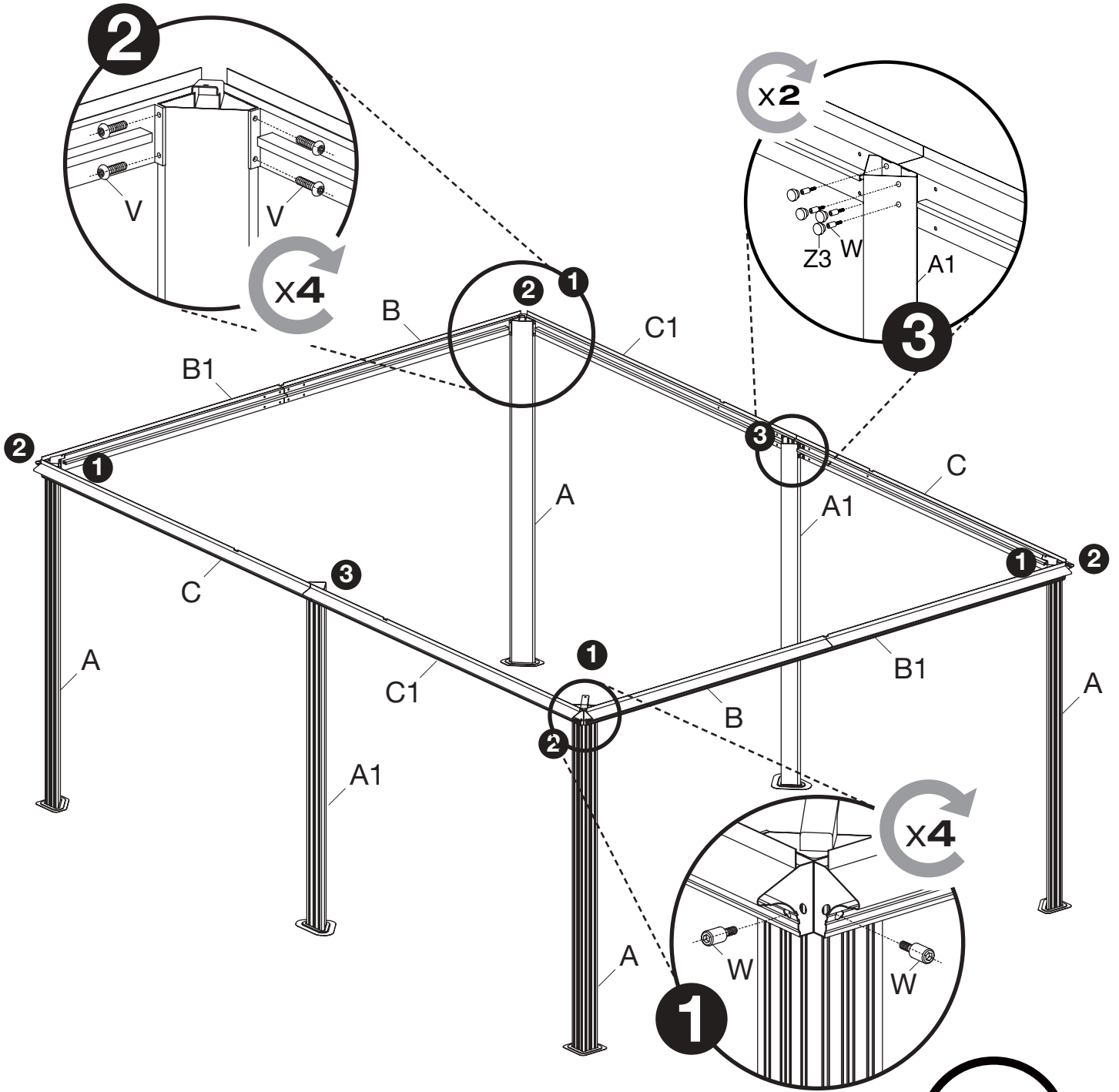

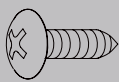
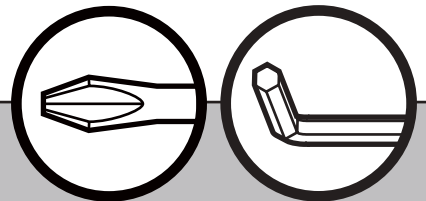
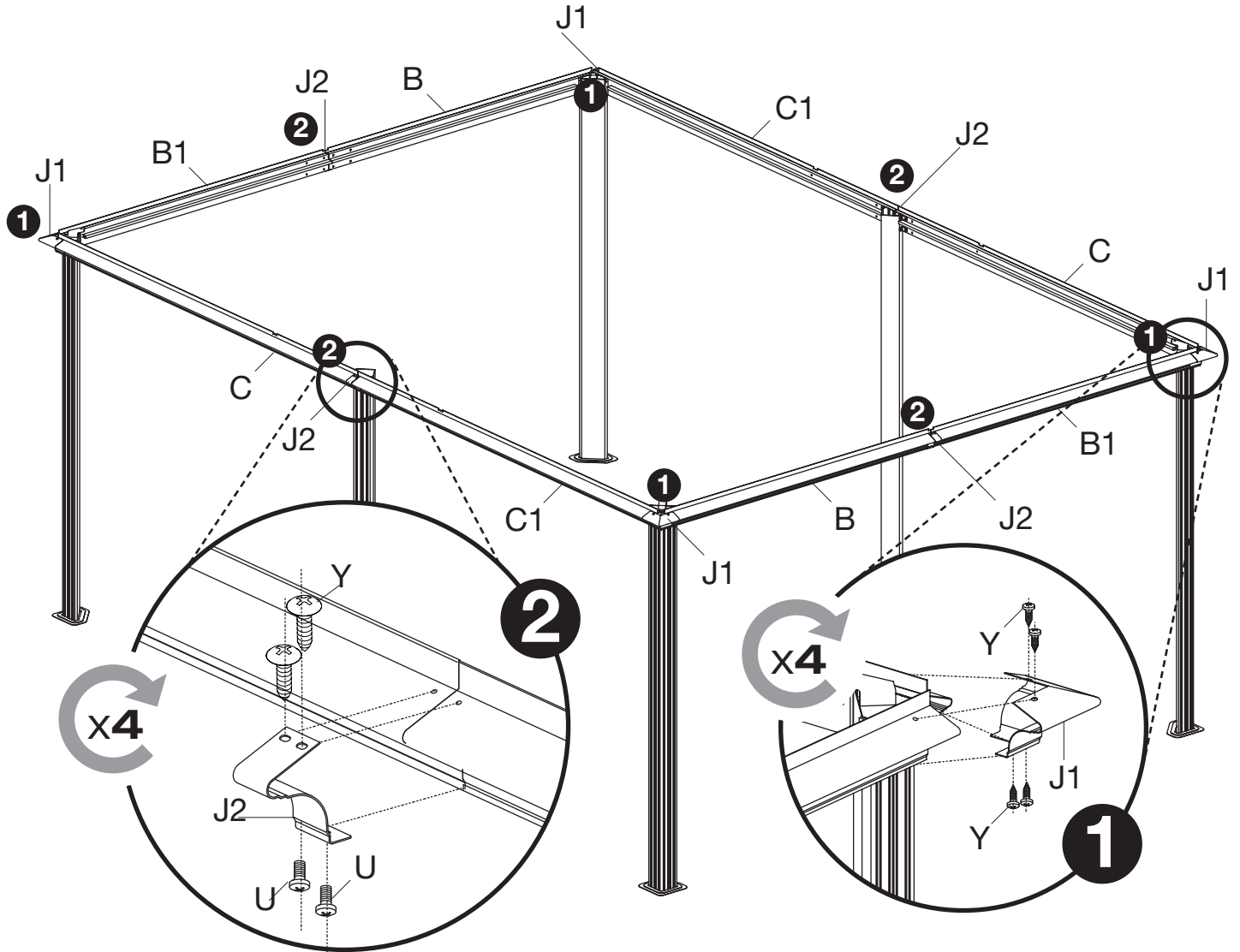

Y x24

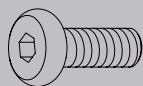

U x8

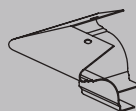

J1 x4



J2 x4

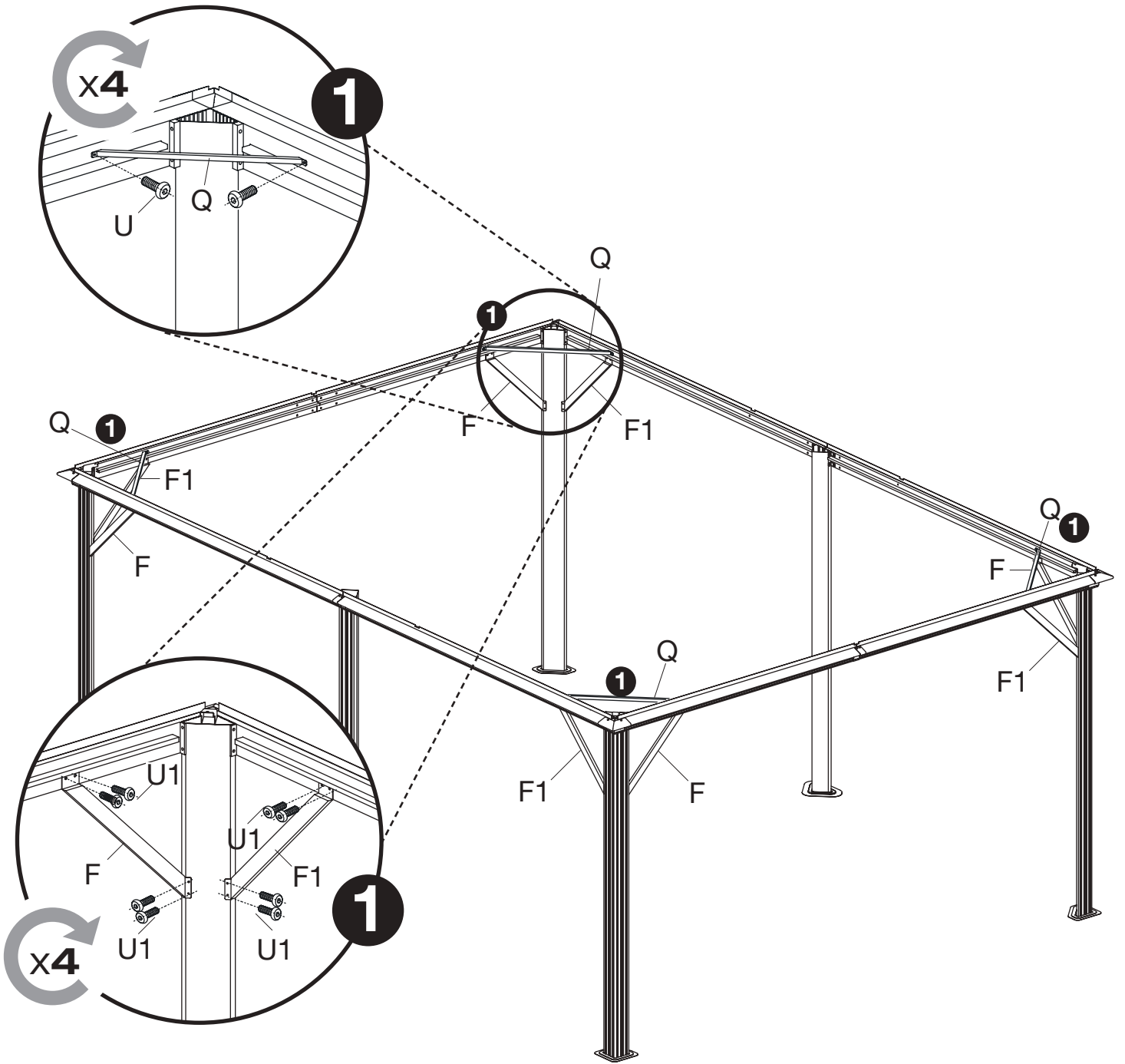

A parts list and assembly tip section. On the left, two long beams are shown, labeled 'F x4' and 'F1 x4'. In the center, a shorter beam is labeled 'Q x4'. To the right, two bolts are shown, labeled 'U x8' and 'U1 x32'. On the far right, a circular icon shows a corner bracket being inserted into a joint.

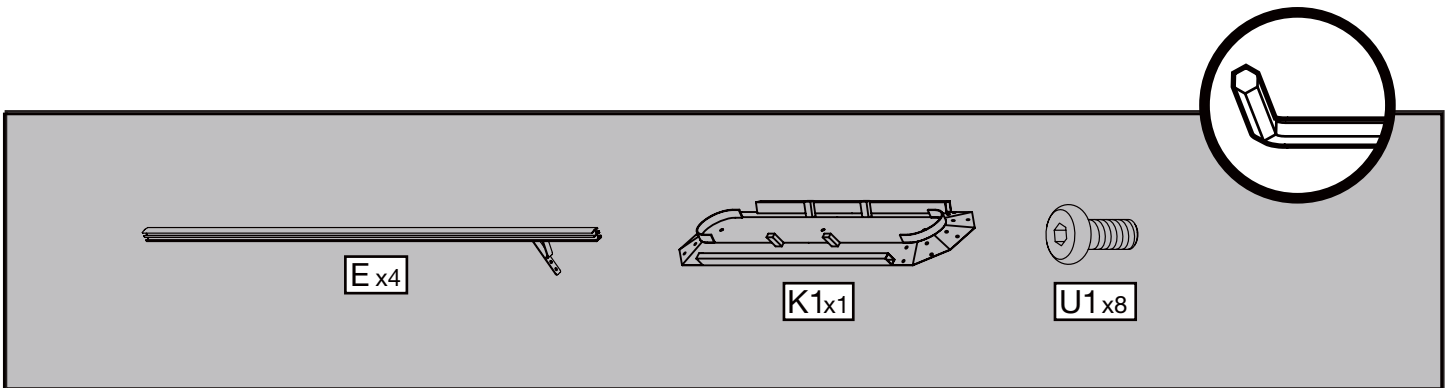
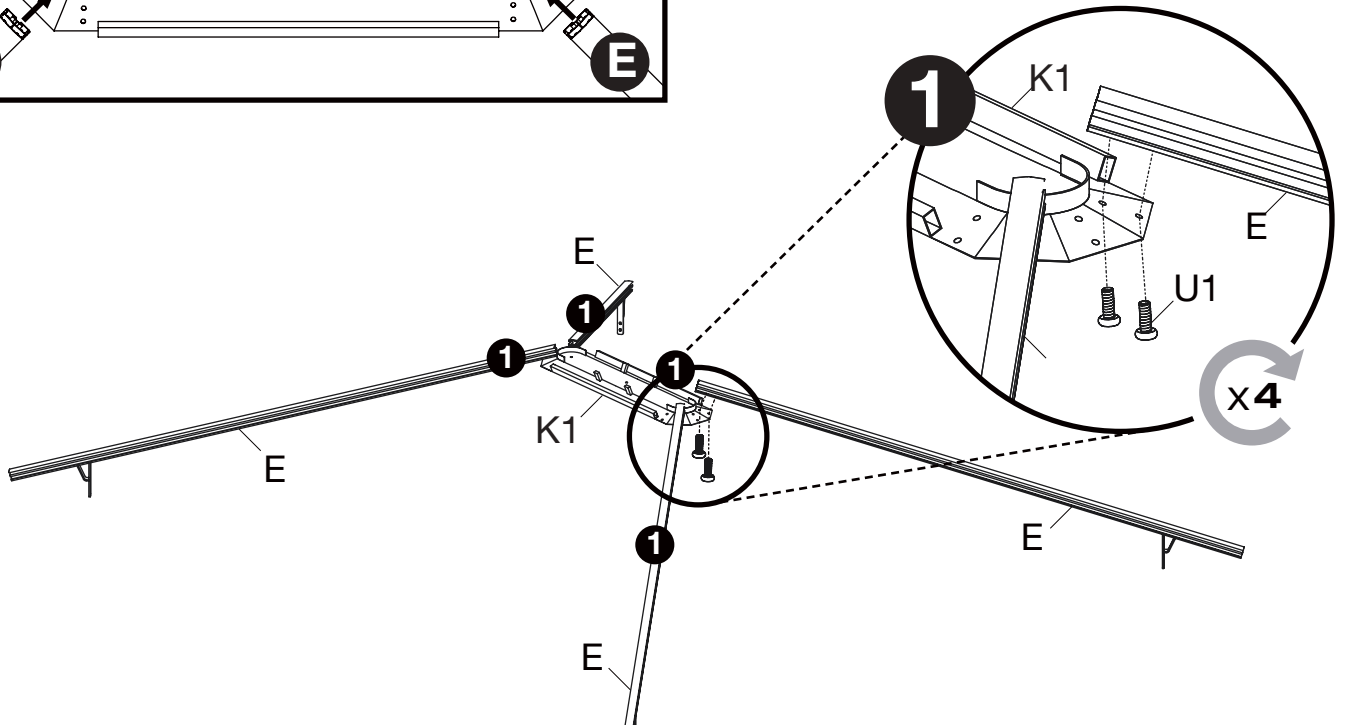
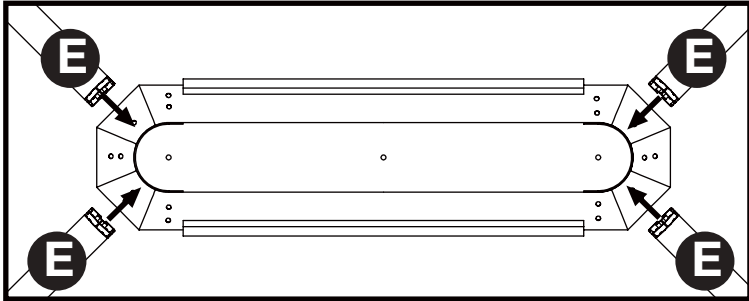

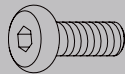
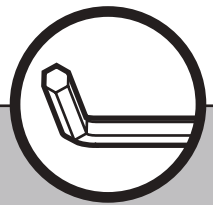
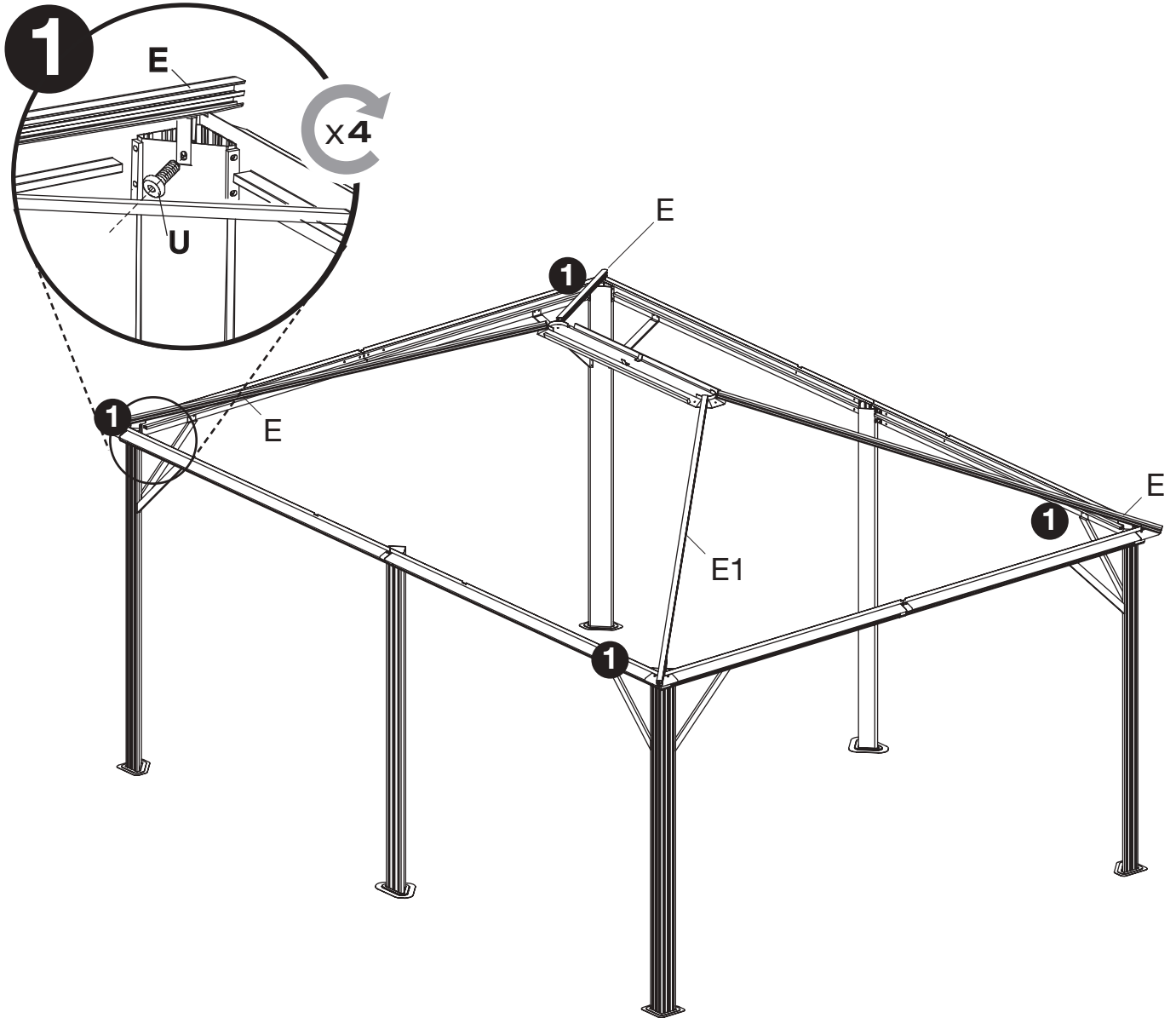

Ux4

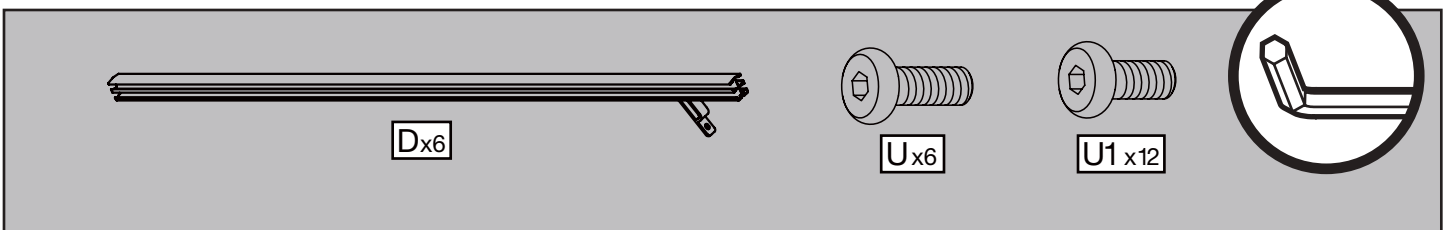
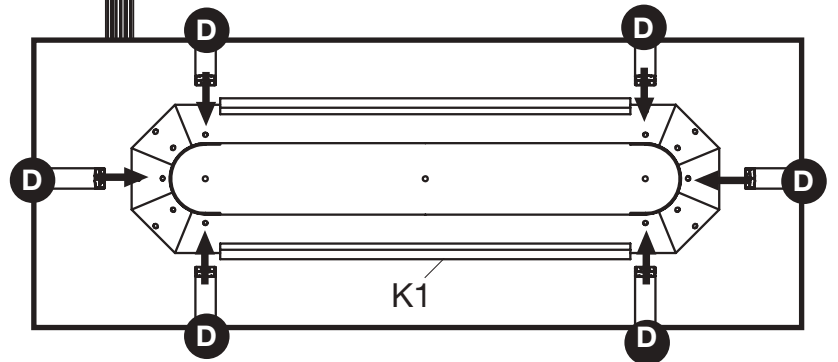
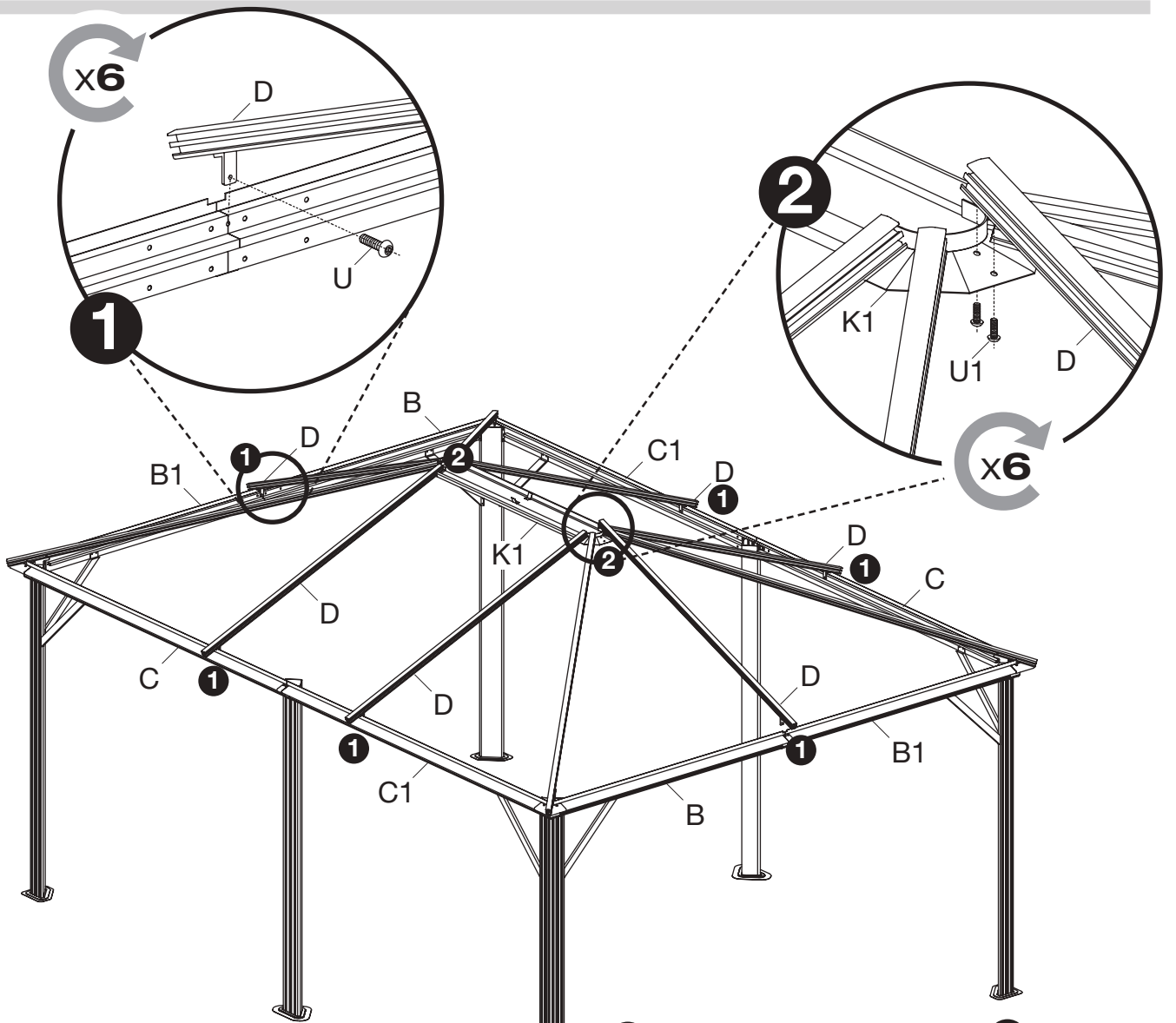

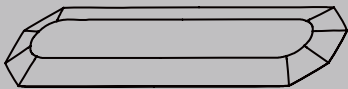
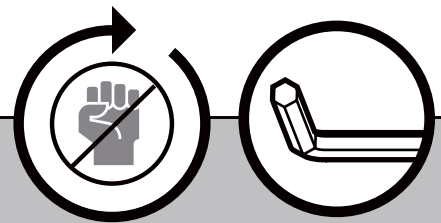
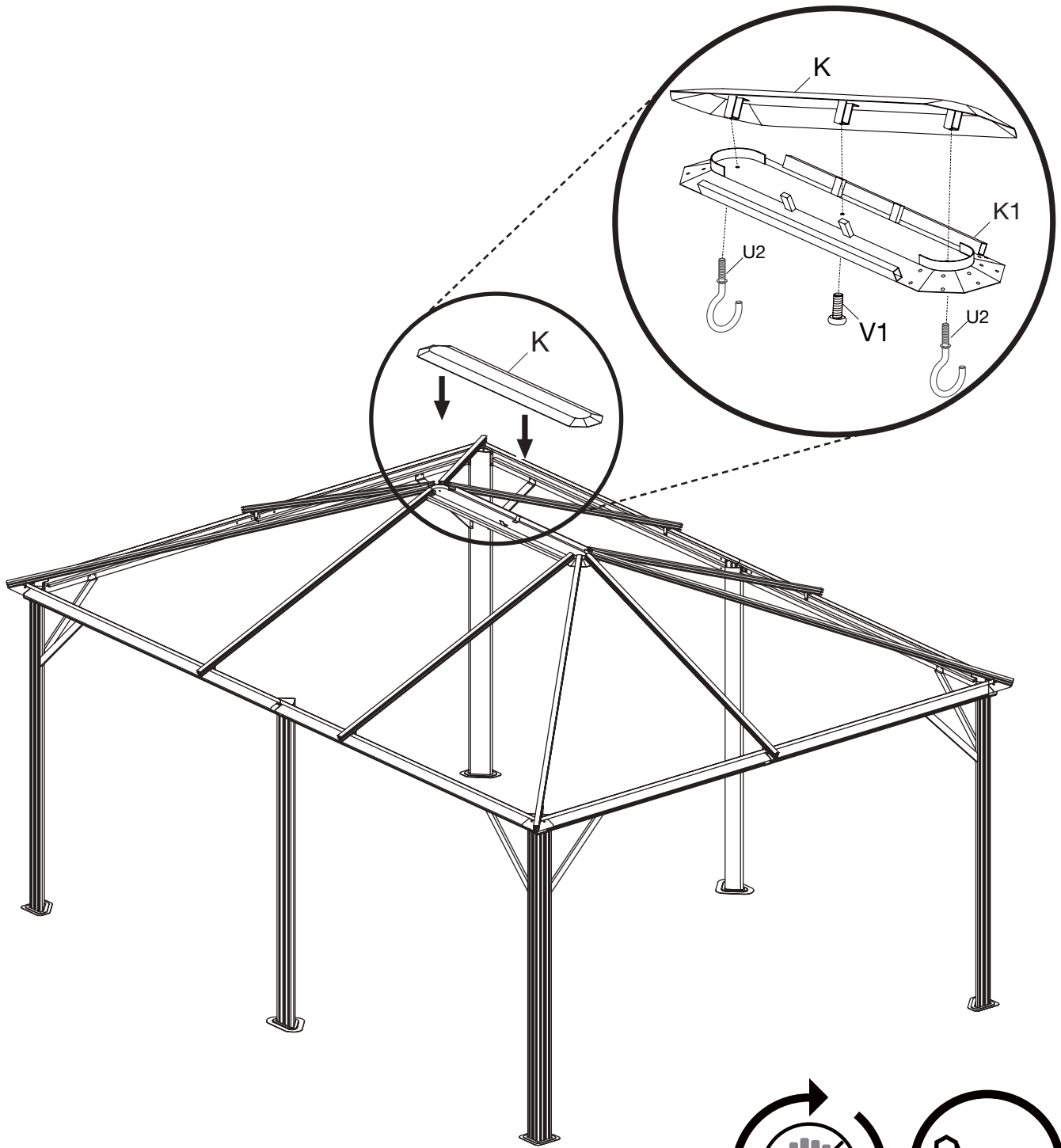

Kx1

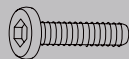

V1 x1



U2 x2

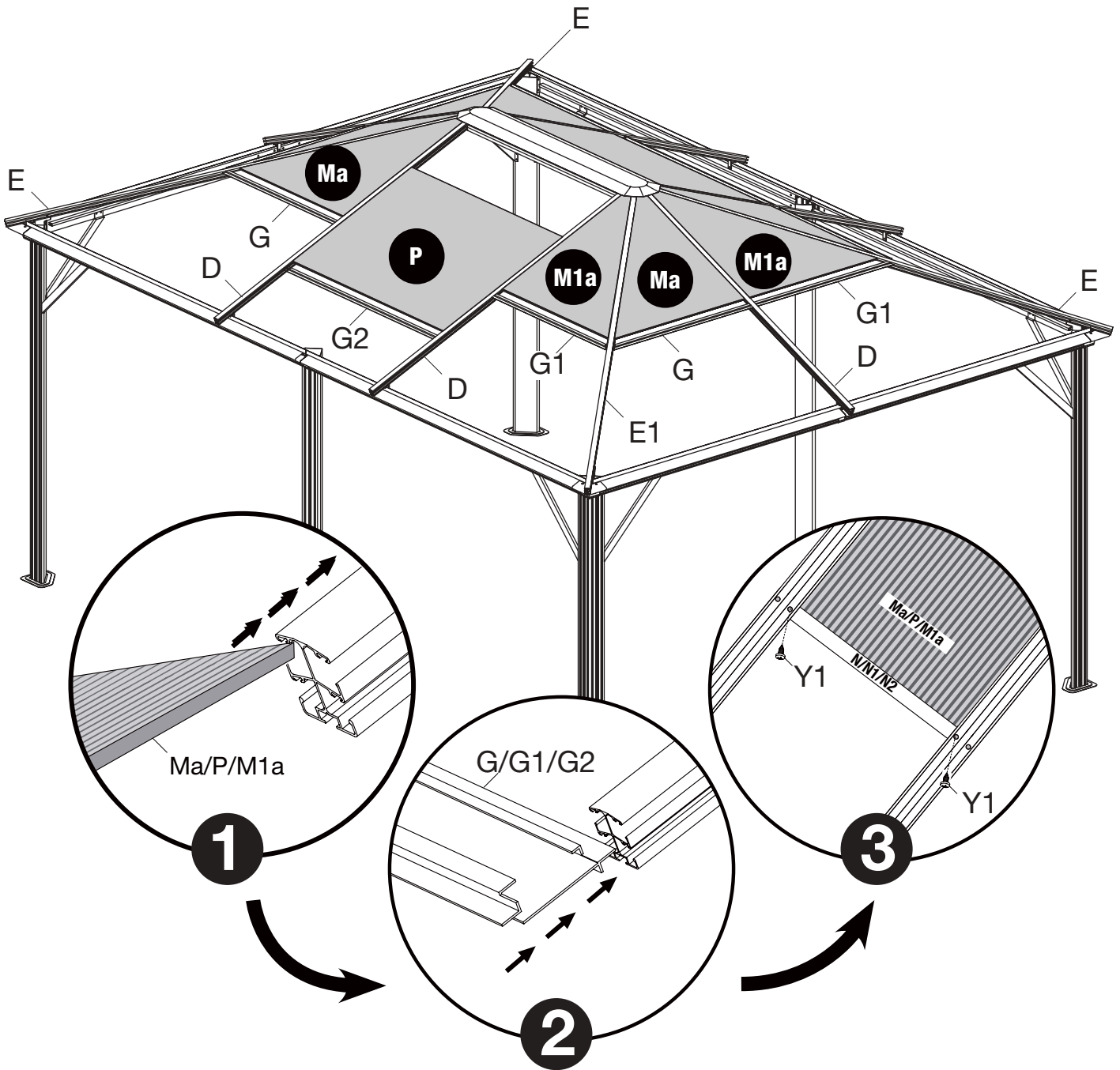

A parts list and safety icon are located at the bottom of the page. The parts list includes:

- Ma x4 (represented by a triangle)
- P x2 (represented by a rectangle)
- M1a x4 (represented by a trapezoid)
- Y1 x20 (represented by a screw)
- G x4 (represented by a beam)
- G1 x4 (represented by a beam)
- G2 x2 (represented by a beam)

A safety icon of a pair of hands is also present.

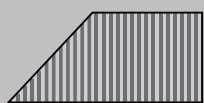
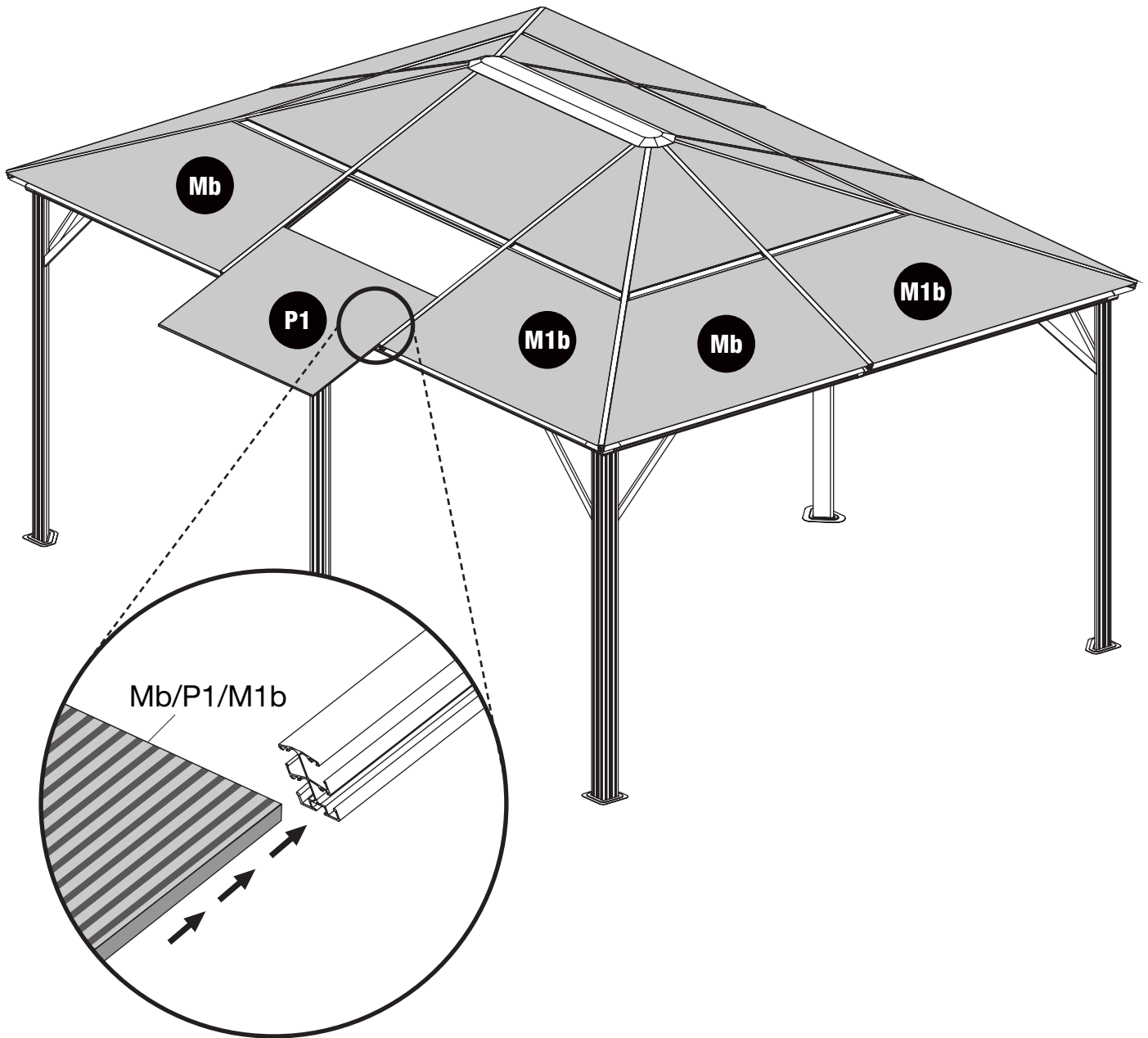

Mb_{x4}



P1_{x2}

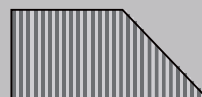

M1b_{x4}

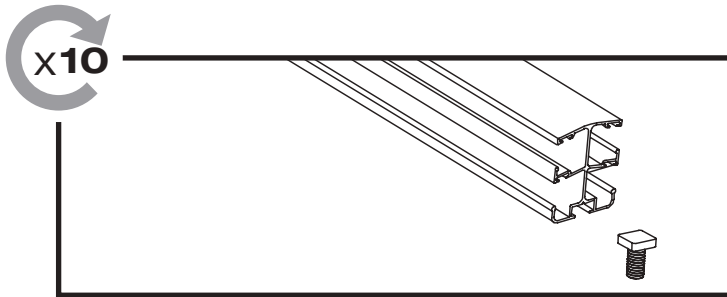
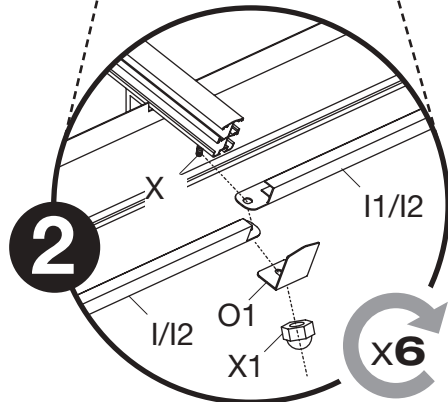
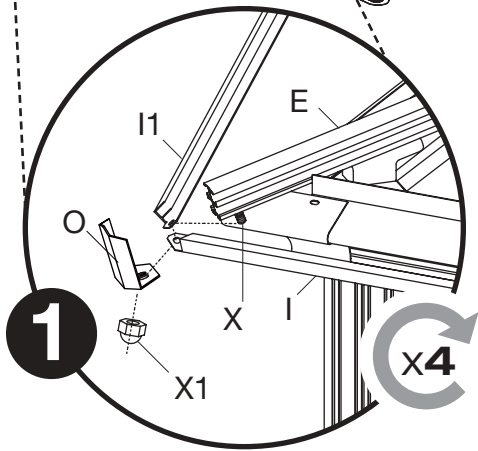
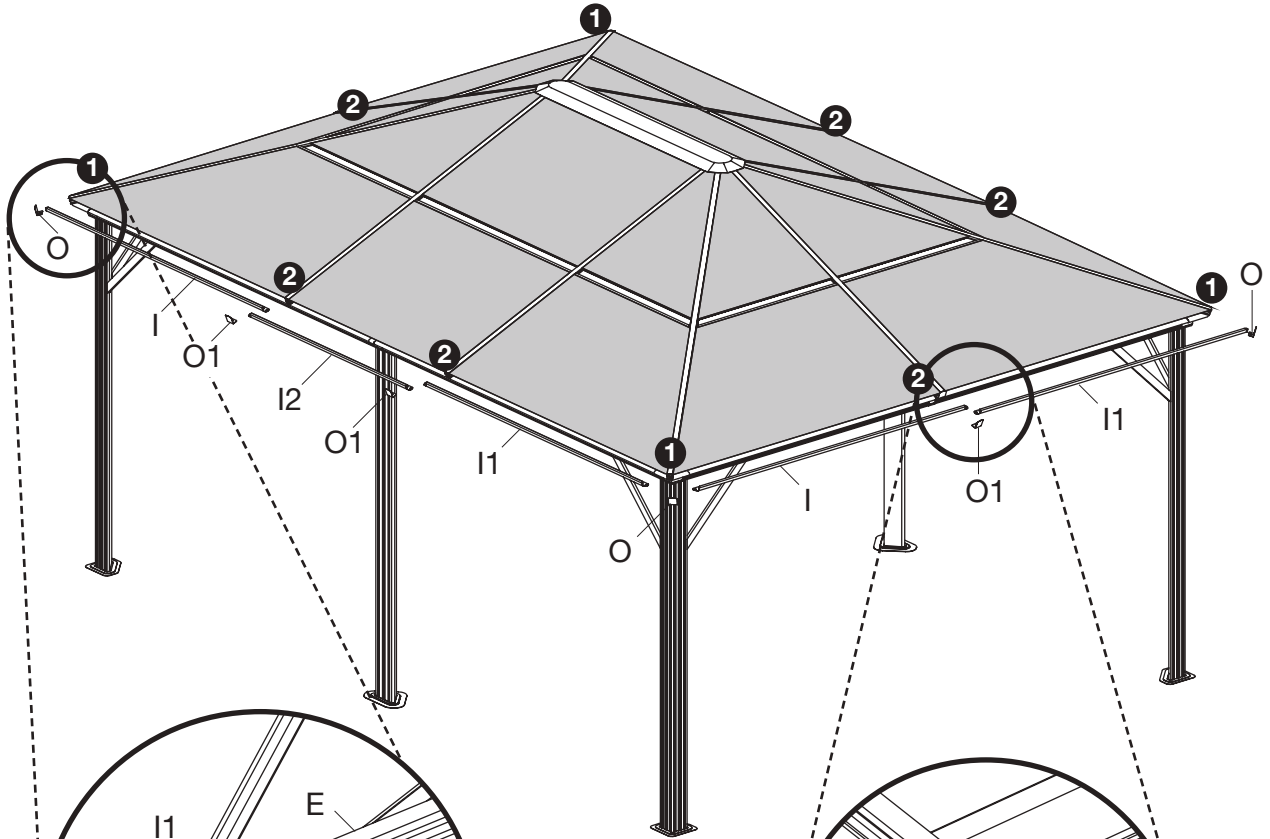

I x4



I2 x2



I1 x4



O x4



O1 x6









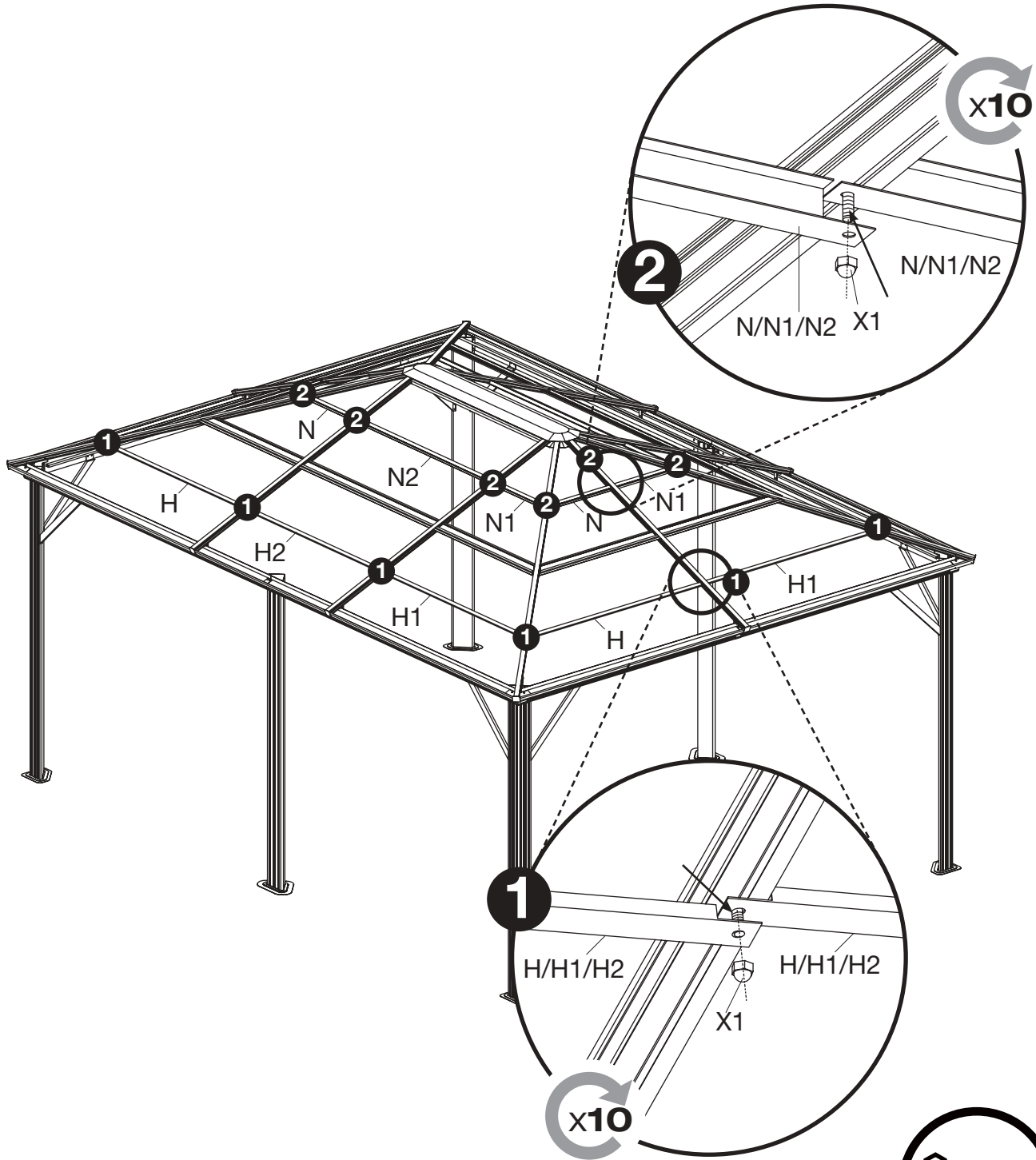

X x10



X1 x10



- | | | | |
|---|---|---|---|
|  |  |  |  |
| Hx4 | H2x2 | Nx4 | |
|  |  |  |  |
| H1x4 | N2x2 | N1x4 | X1x20 |

