

DANCOVER[®]

.com

Manual
for
Storage Shelter/Arched Tent
12x16x5,88m

DANCOVER[®]

.com

Safety Advice

Attention

In some countries approval is needed to set up a tent larger than 75 m². It is your responsibility to comply with local rules and regulations and to ensure that the tent is assembled correctly.

In case of bad weather conditions, it is your responsibility to ensure the tent is safely secured and that the tent does not cause damage to others.

Do not use open fire, welding equipment or other sources which can ignite, inside or close to the tent.

The tent must be safely secured. We recommend you secure your tent with straps and pegs as soon as it is assembled.

Make sure to check if the tent is covered by your home contents insurance.

Tents must be evacuated under extreme weather conditions.

In the event of snow, always remove snow from the roof of the tent regularly to prevent snow from building on the roof, as heavy snow can cause the tent to collapse.

In the event of rain, there is a risk of rain puddles building up on top of the roof of the tent. Heavy rain puddles can cause the roof to collapse. It is your responsibility to ensure rain puddles do not build up. As a precaution, make sure the roof of the tent is stretched out properly and adequately over the side frames of the tent and remove rain water regularly.

Do not unpack or repack your tent in freezing temperatures. In case of temperatures below zero, always unpack and repack your tent indoors to avoid the risk of cracking parts.





The tent must be totally dry before you repack and store it to avoid mildew.

Note: Dancover warranty applies only to the normal use of the Product, normal wear and tear excepted, in accordance with written use instructions or manual. The warranty does not apply to damage caused by accident, abuse, misuse, or modification of the Product.

Warranty Information

Please visit dancovershop.com for information on warranty.

Please always check our website for the latest safety advice and manual.



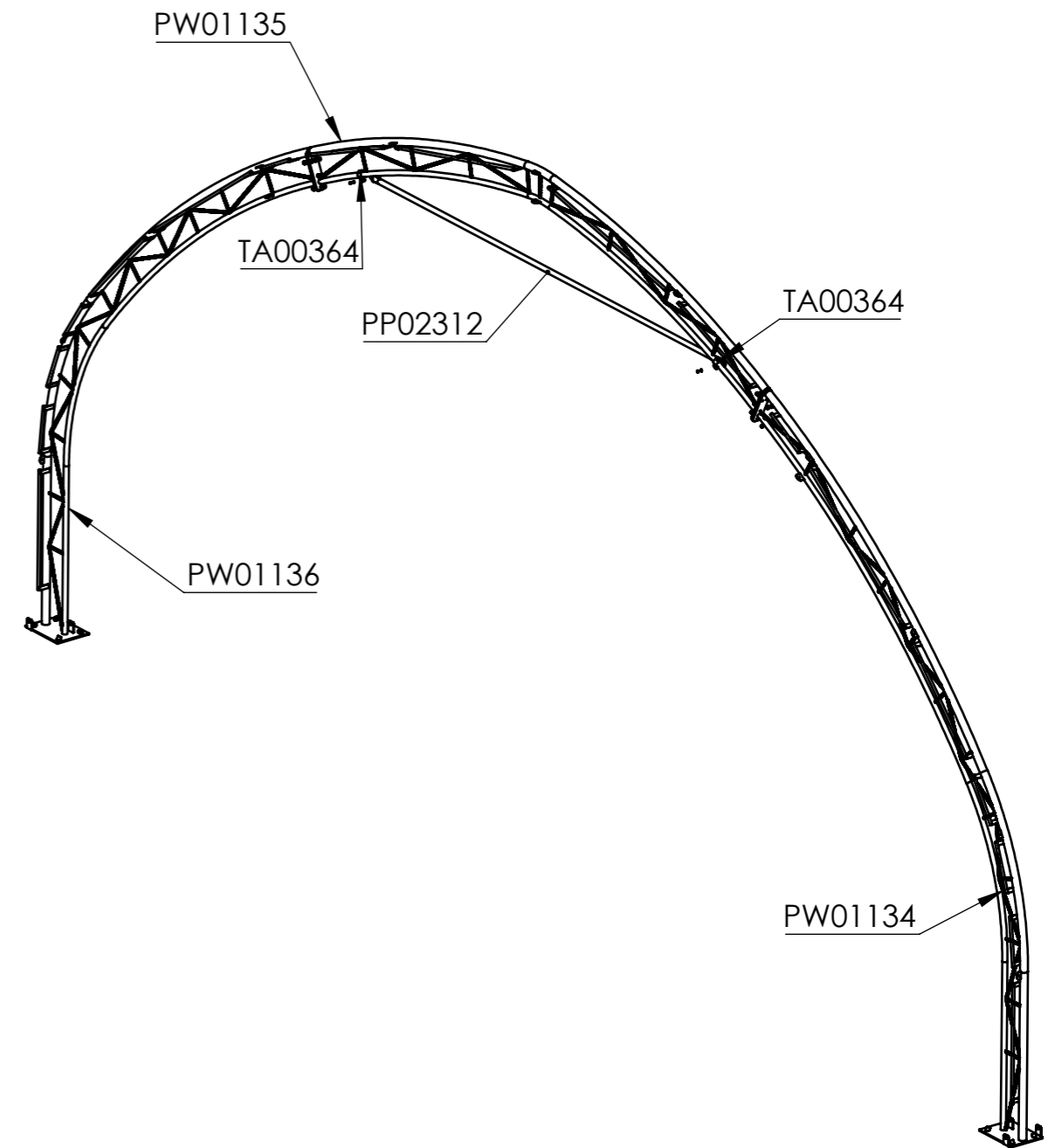



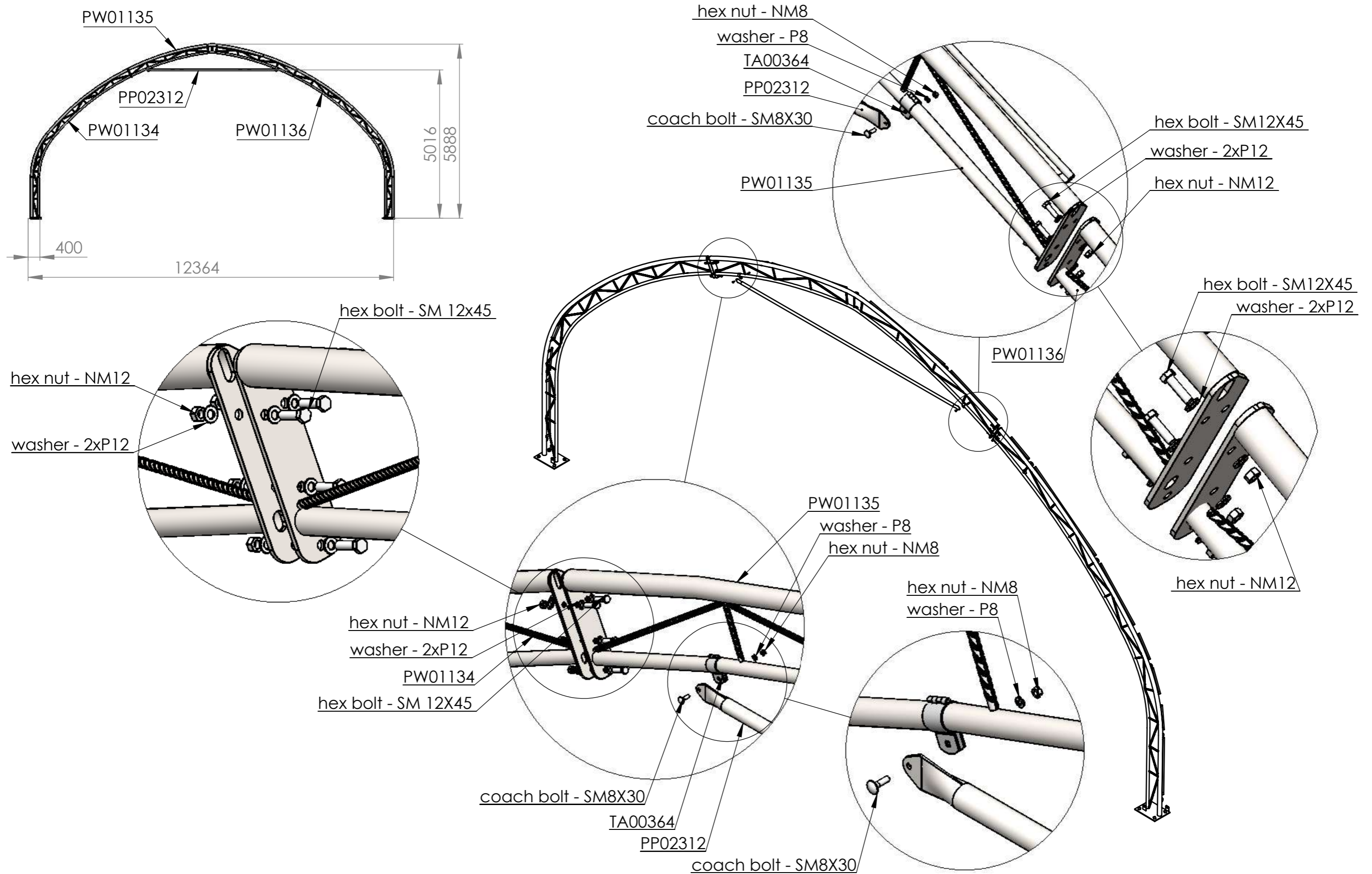



No.	Number	Description	Element View	Weight [kg]	Amount
1	PW01134	Right Steel Welded Column the Gable End Section		53,0	1
2	PW01136	Left Steel Welded Column the Gable End Section		53,0	1
3	PW01135	Bottom Steel Welded Ridge Beam the End Gable Section		45,2	1
4	PP02312	Circular Hollow Section 40.0x2.5 / L=4464mm		10,7	1
5	TA00364	Pipe Clamp Φ 40		0,1	2
6		SM12X45 DIN933-8.80C			8
7		P12-DIN125A-OC			16
8		NM12-DIN934-8.80C			8
9		SM8X30 DIN603-8.80C			2
10		P8-DIN125A-OC			2
11		NM8-DIN934-8.80C			2



mounting instruction - gable frame



mounting instruction - gable frame



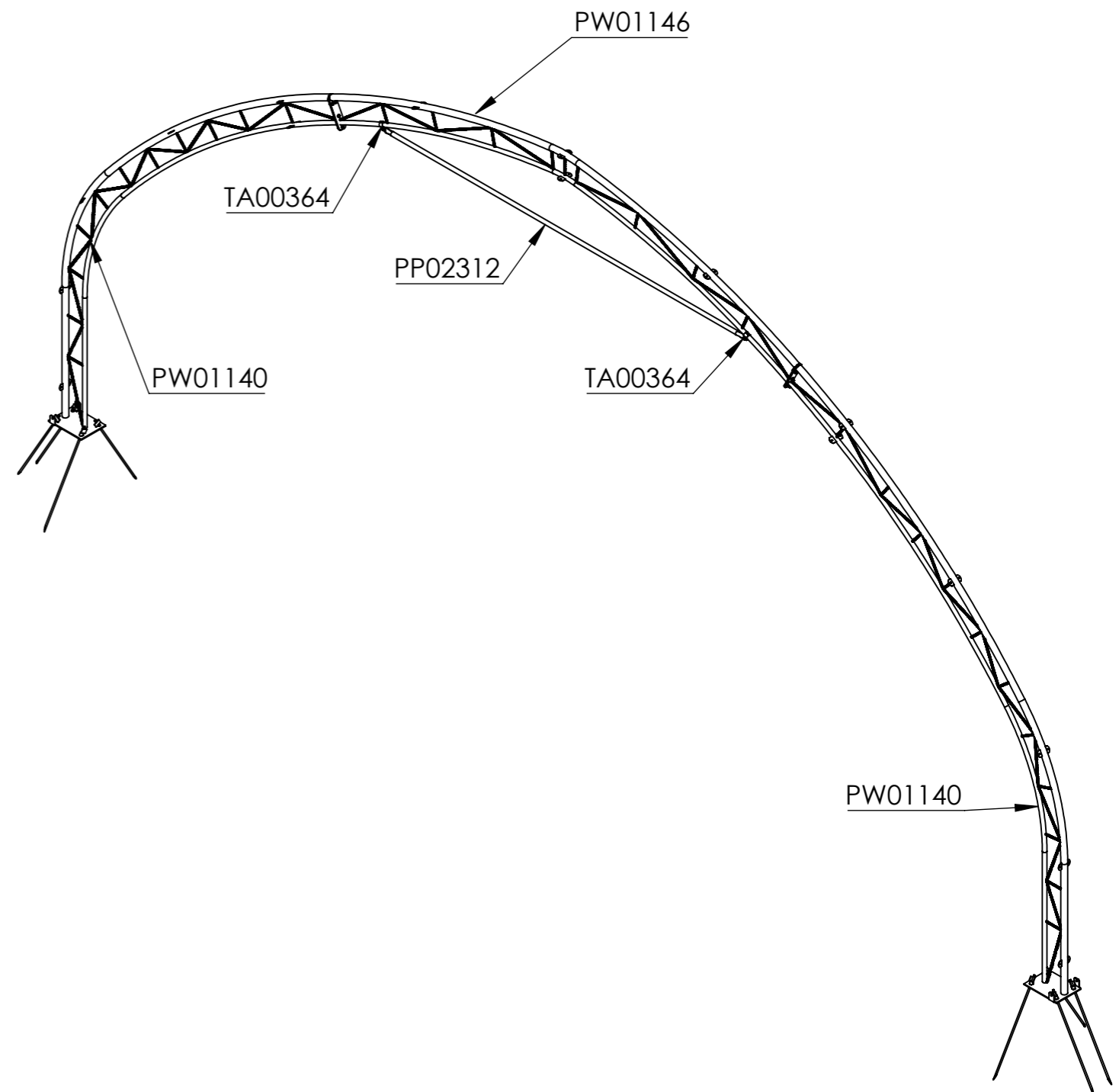



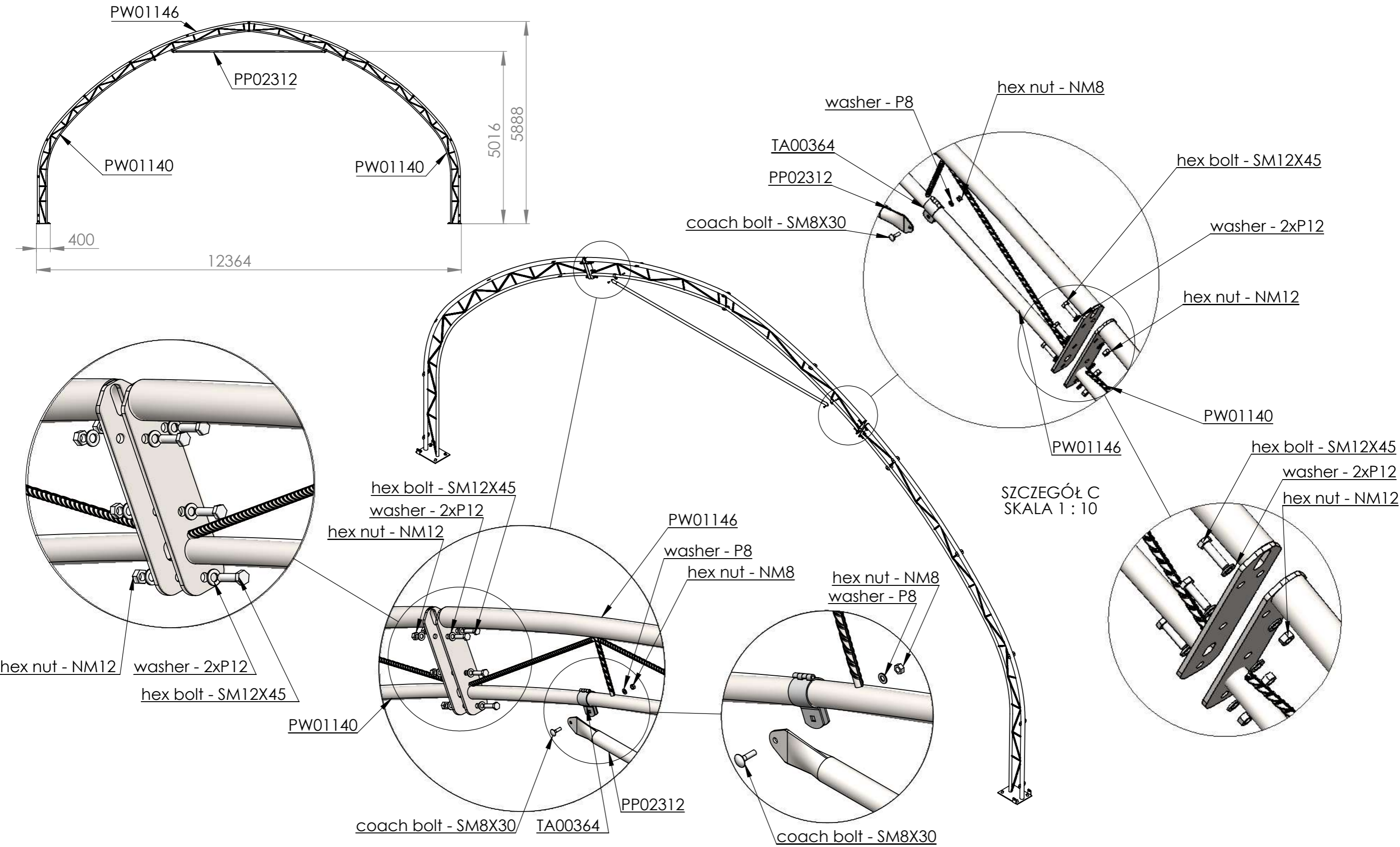



No.	Number	Description	Element View	Weight [kg]	Amount
1	PW01140	Middle Steel Welded Column		47,5	2
2	PW01146	Bottom Steel Welded Ridge Beam the Middle Gable Section		40,2	1
3	PP02312	Circular Hollow Section 40.0x2.5 / L=4464mm		10,7	1
4	TA00364	Pipe Clamp Φ40		0,1	2
5		SM12X45 DIN933-8.8OC			8
6		P12-DIN125A-OC			16
7		NM12-DIN934-8.8OC			8
8		SM8X30 DIN603-8.8OC			2
9		P8-DIN125A-OC			2
10		NM8-DIN934-8.8OC			2



mounting instruction - middle frame



mounting instruction - middle frame

No.	Number	Description	Element View	Weight [kg]	Amount
1	PW00349	Tent Pin		1,6	8
2	PP02311	Circular Hollow Section 40.0x2.5 / L=1922mm		4,5	7
3	PP02307	Circular Hollow Section 40.0x2.5 / L=1924mm		4,2	4
4	PP02308	Circular Hollow Section 40.0x2.0 / L=1943mm		4,2	3
5	PP02334	Circular Hollow Section 40.0x1.5 / L=1600mm		2,6	8
6	PP02335	Circular Hollow Section 35.0x1.5 / L=1600mm		2,2	8
7		SM8X25 DIN603-8.8OC			18
8		SM8X35 DIN603-8.8OC			12
9		P8-DIN125A-OC			30
10		NM8-DIN934-8.8OC			30

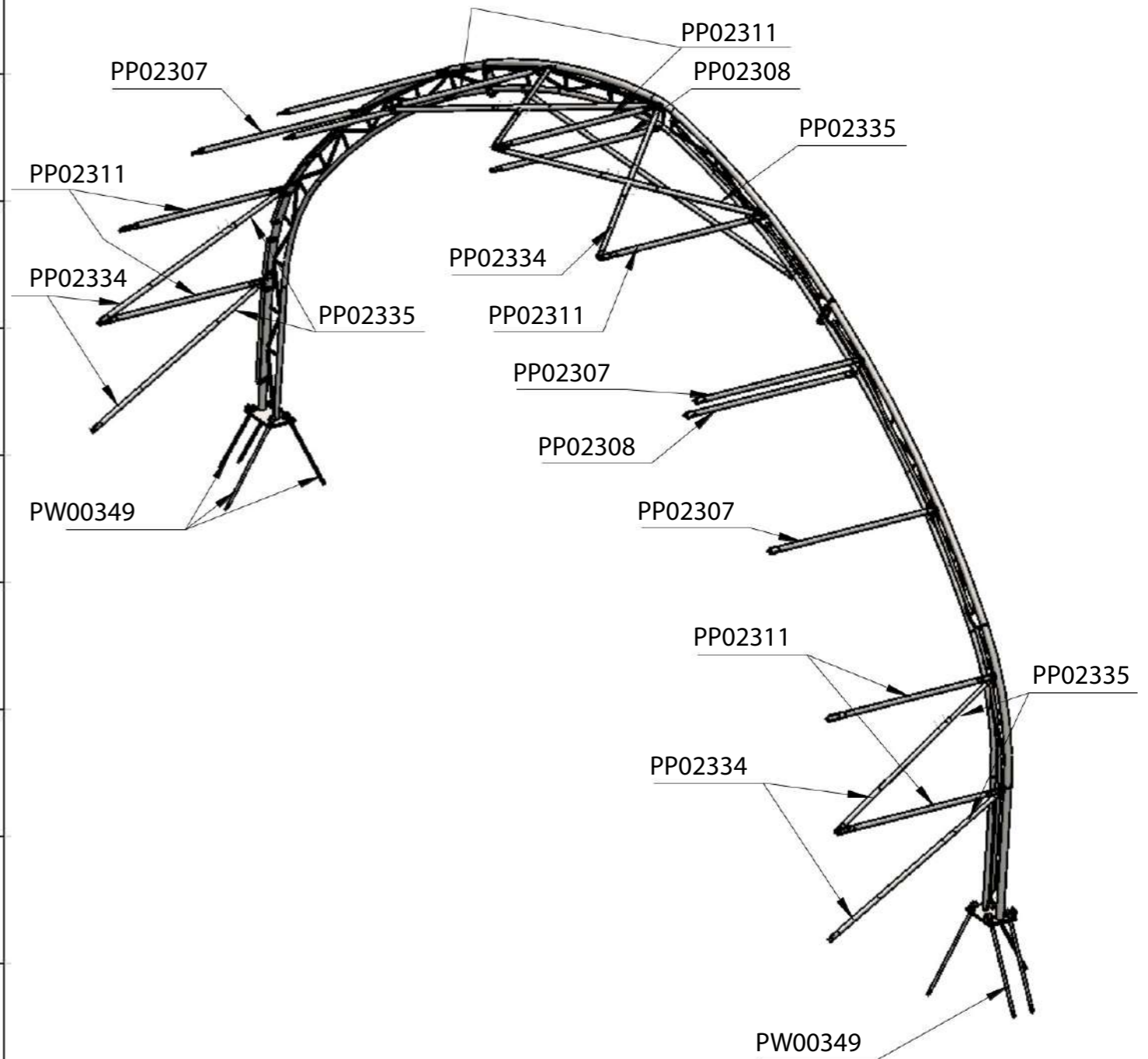



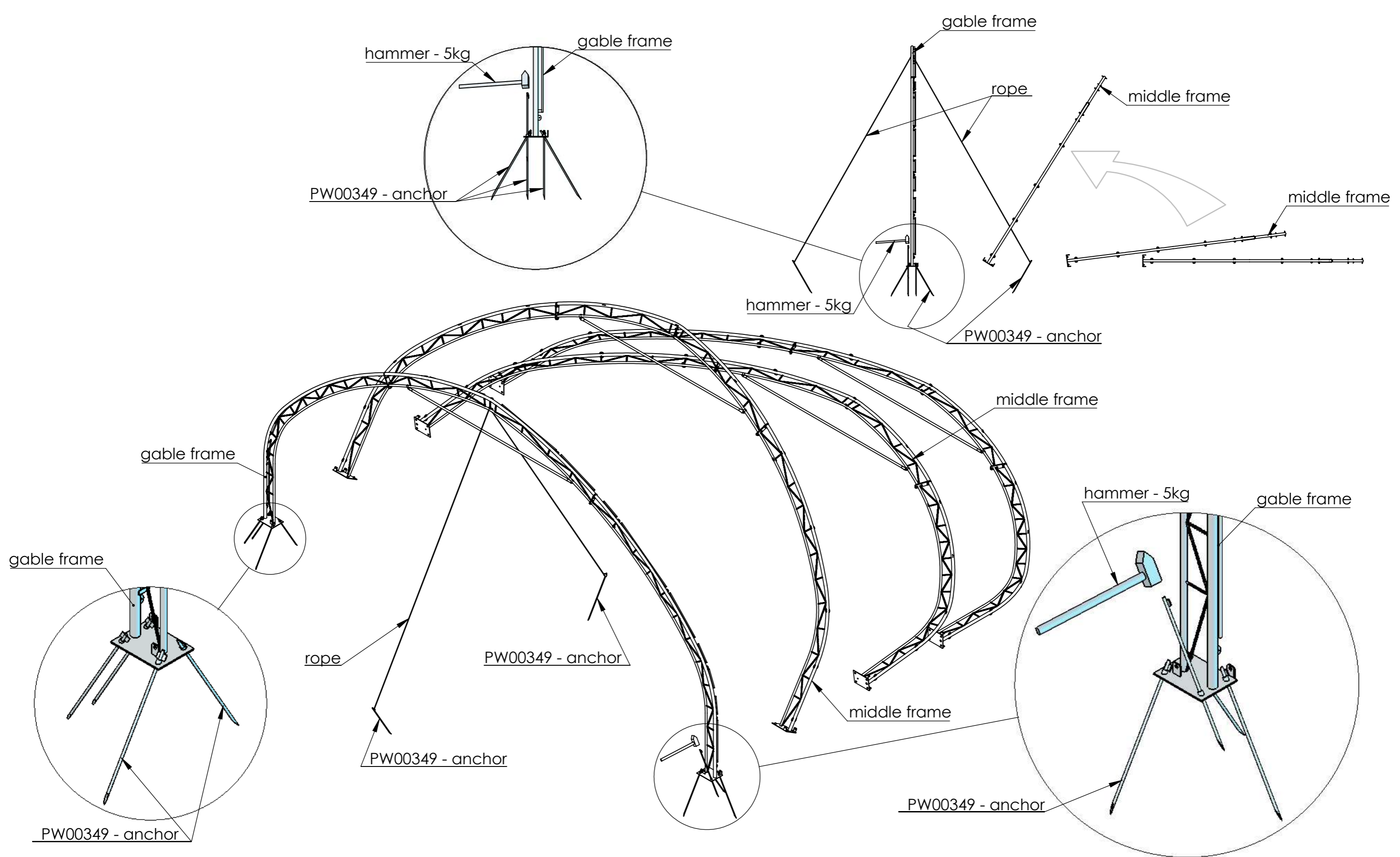

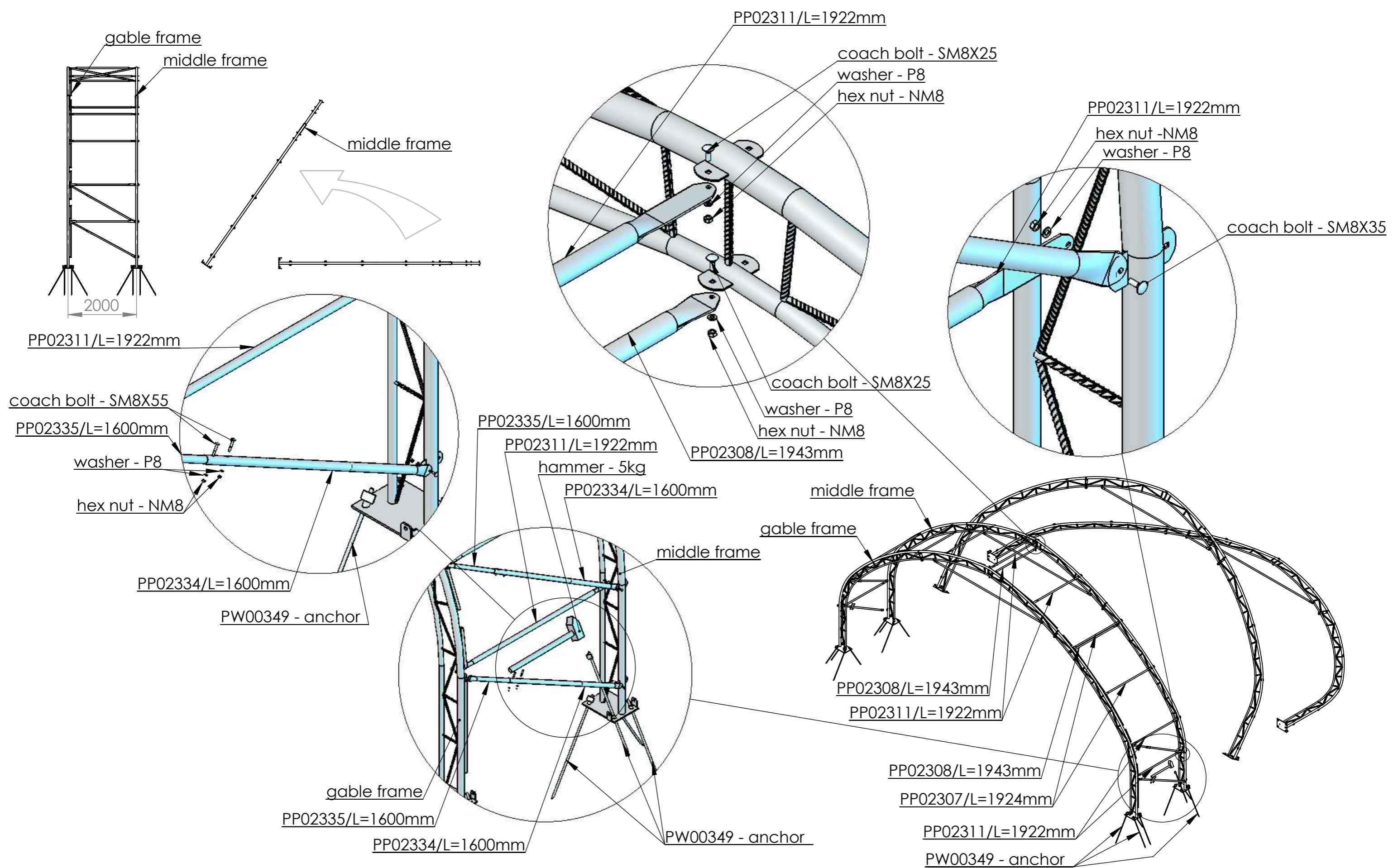

mounting instruction - list of struts for gable frame



mounting instruction - mounting of struts for first section



mounting instruction - mounting of struts for first section



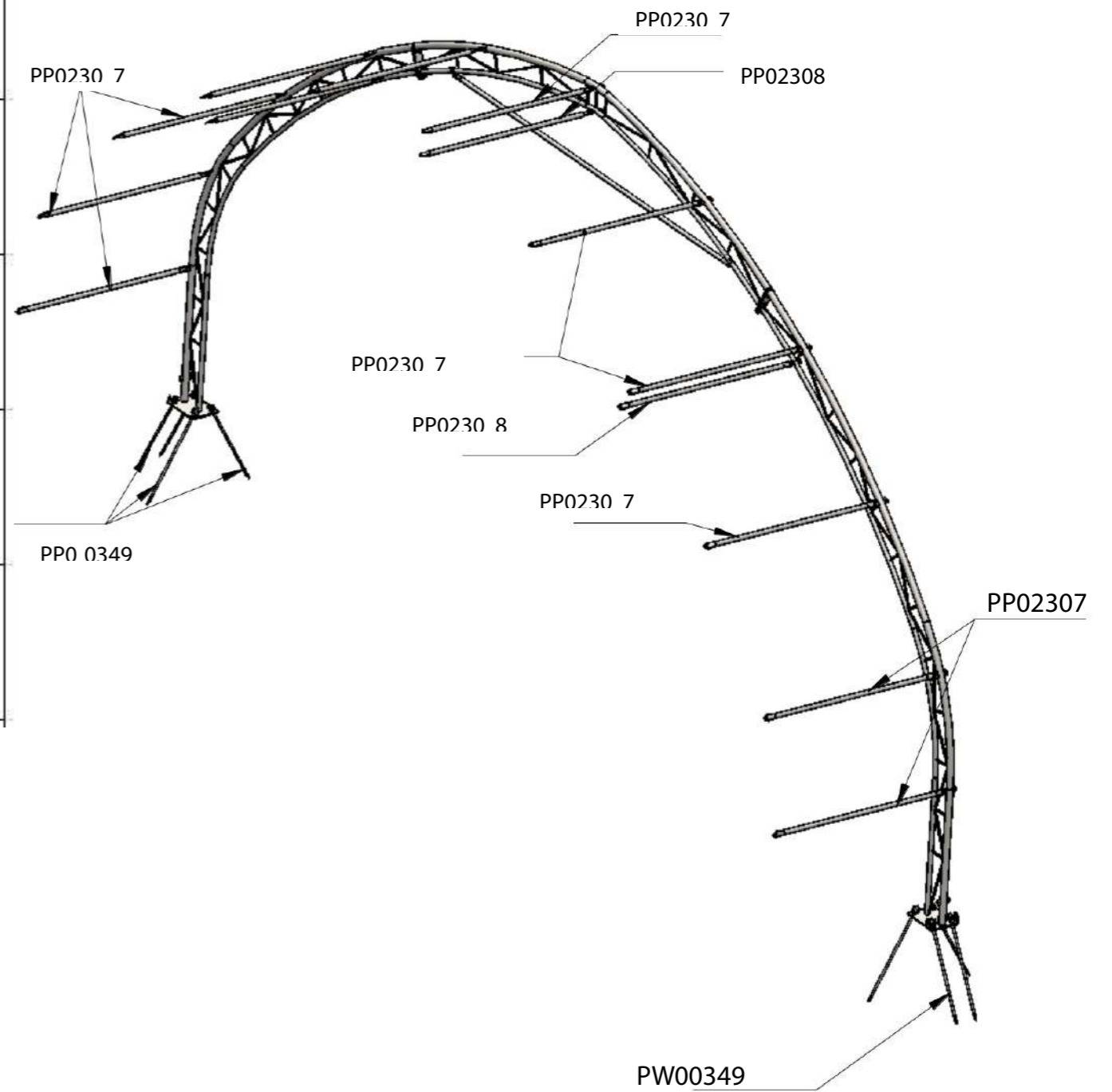



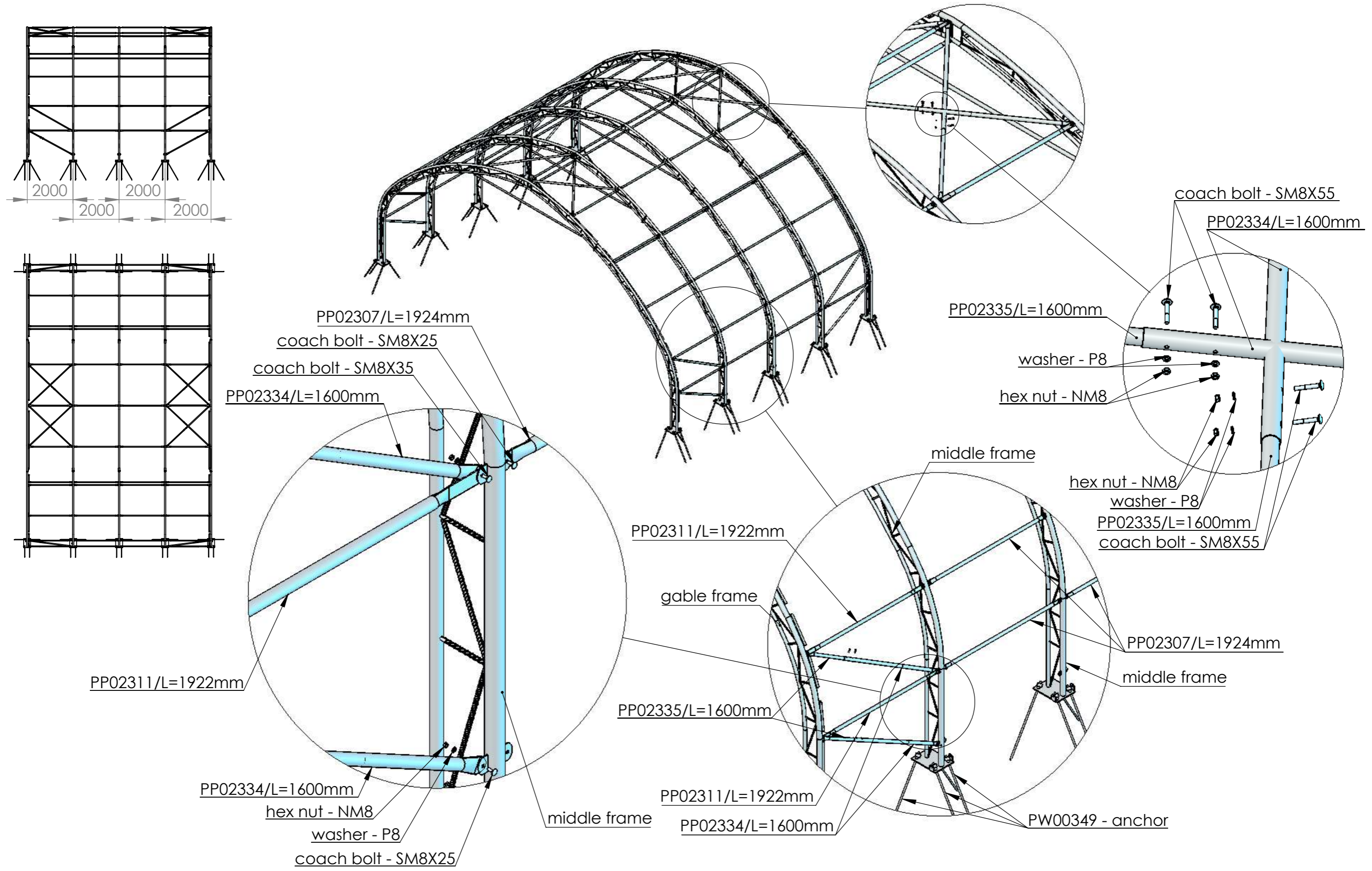



No.	Number	Description	Element View	Weight [kg]	Amount
1	PW00349	Tent Pin		1,6	8
2	PP02307	Circular Hollow Section 40.0x2.5 / L=1924mm		4,2	11
3	PP02308	Circular Hollow Section 40.0x2.0 / L=1943mm		4,2	3
4		SM8X25 DIN603-8.8OC			28
5		P8-DIN125A-OC			28
6		NM8-DIN934-8.8OC			28



mounting instruction - list of struts for middle frame



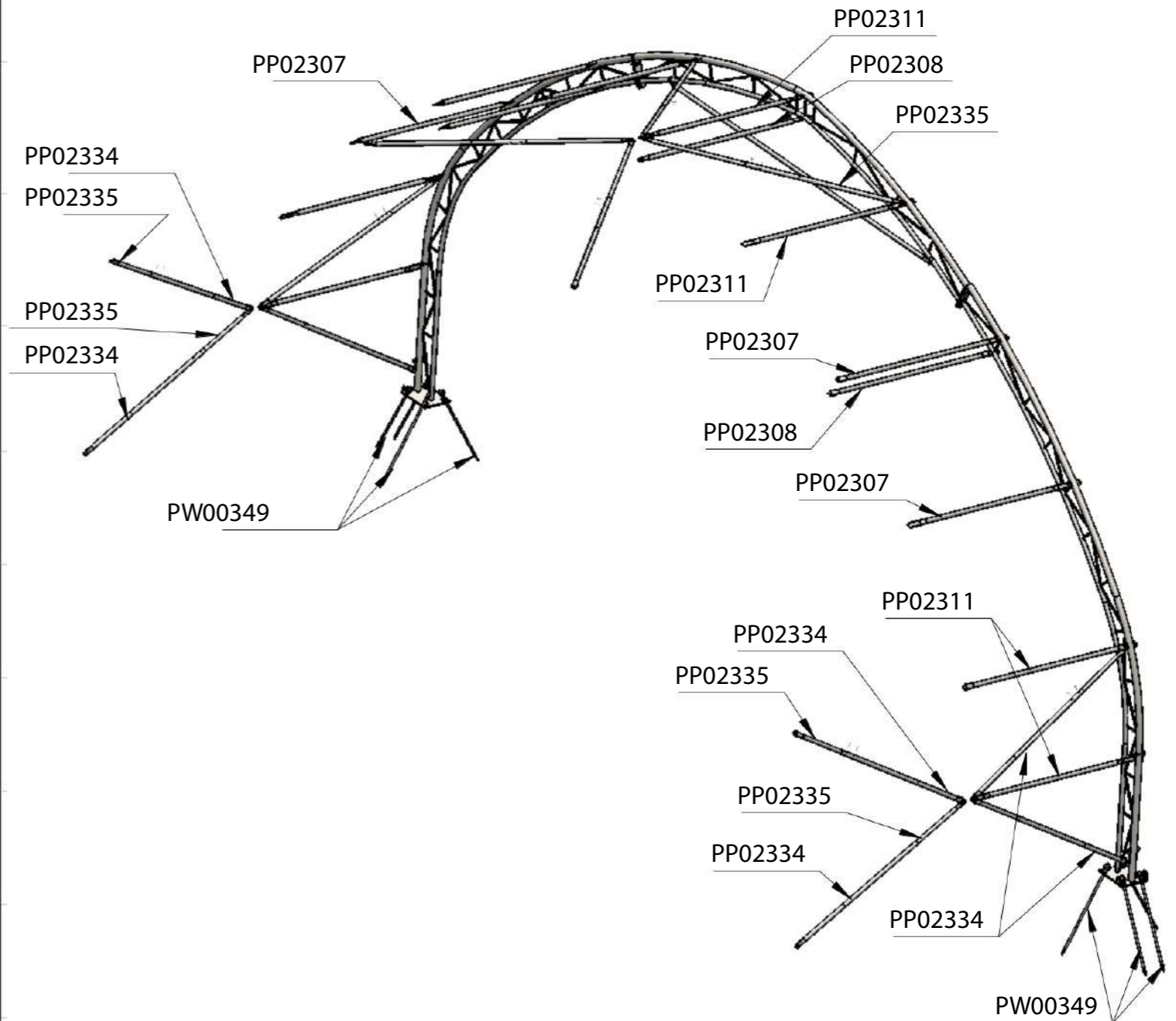

mounting instruction - layout of struts in hall

No.	Number	Description	Element View	Weight [kg]	Amount
1	PW00349	Tent Pin		1,6	8
2	PP02311	Circular Hollow Section 40.0x2.5 / L=1922mm		4,5	7
3	PP02307	Circular Hollow Section 40.0x2.5 / L=1924mm		4,2	4
4	PP02308	Circular Hollow Section 40.0x2.0 / L=1943mm		4,2	3
5	PP02334	Circular Hollow Section 40.0x1.5 / L=1600mm		2,6	12
6	PP02335	Circular Hollow Section 35.0x1.5 / L=1600mm		2,2	12
7		SM8X25 DIN603-8.8OC			18
8		SM8X35 DIN603-8.8OC			14
9		P10-DIN125A-OC			32
10		NM10-DIN934-8.8OC			32



note:
frame with extra struts used in the hall from 20m length

mounting instruction - list of struts for middle frame

No.	Number	Description	Element View	Weight [kg]	Amount
1	PP06935	Rectangular Hollow Section 60x40x3 / L=1800mm		7,6	2
2	PW01685	Tent Pin for Mount the Taurpaulin		0,5	4
3		SM16x45-DIN933-8.8OC			4
4		P16-DIN125A-OC			8
5		NM16-DIN934-8.8OC			4
6		P12-DIN125A-OC			4
7		NM12-DIN934-8.8OC			4
8		Profile End Cap			4

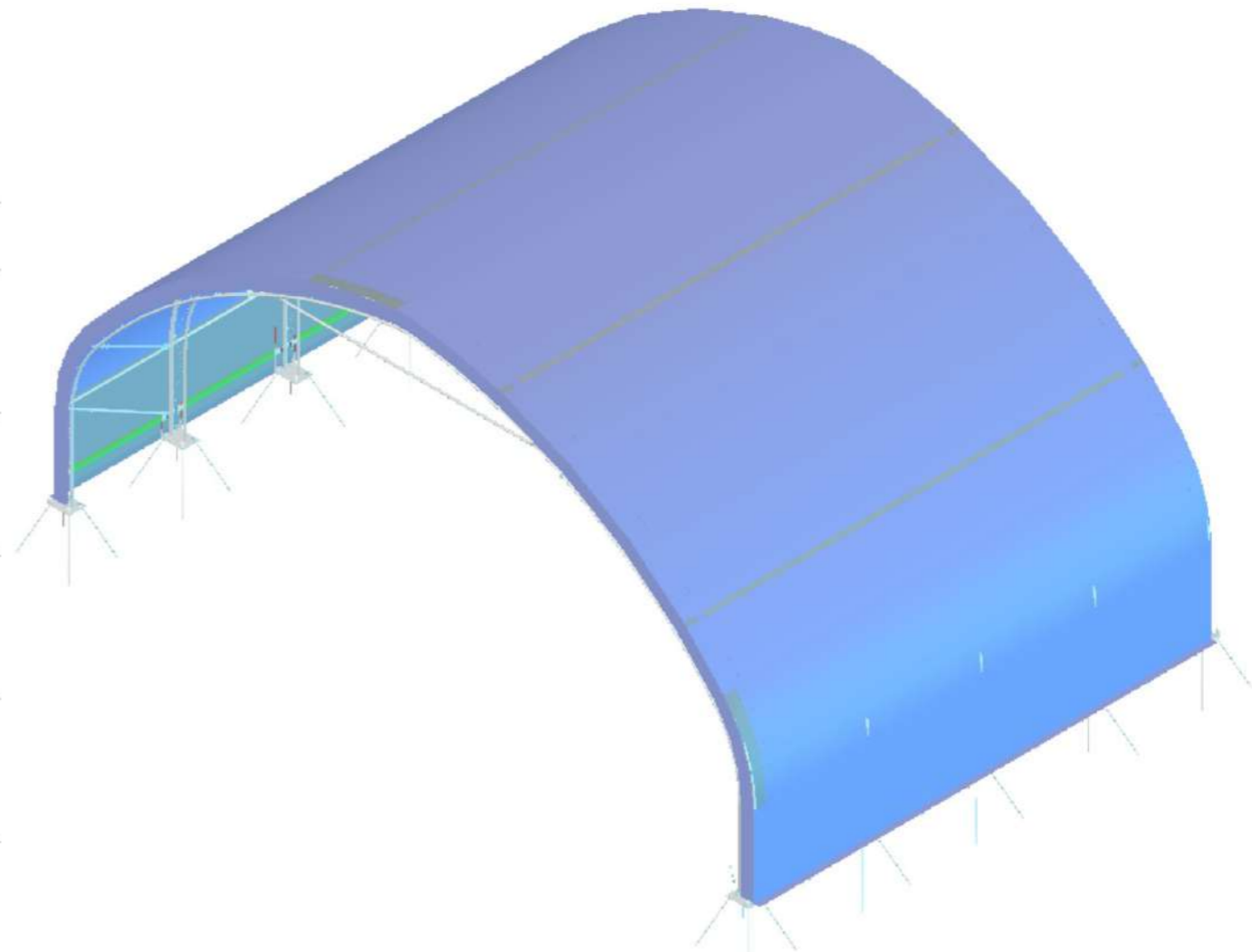

No.	Number	Description	Element View	Weight [kg]	Amount
1	KK01122	Tightening screw M10		0,3	4
2	KK01259	Wire Rope Clamp			8
3		Thimble stainless			4
4		Roof Tarpaulin			1

mounting instruction - components for tension canvas

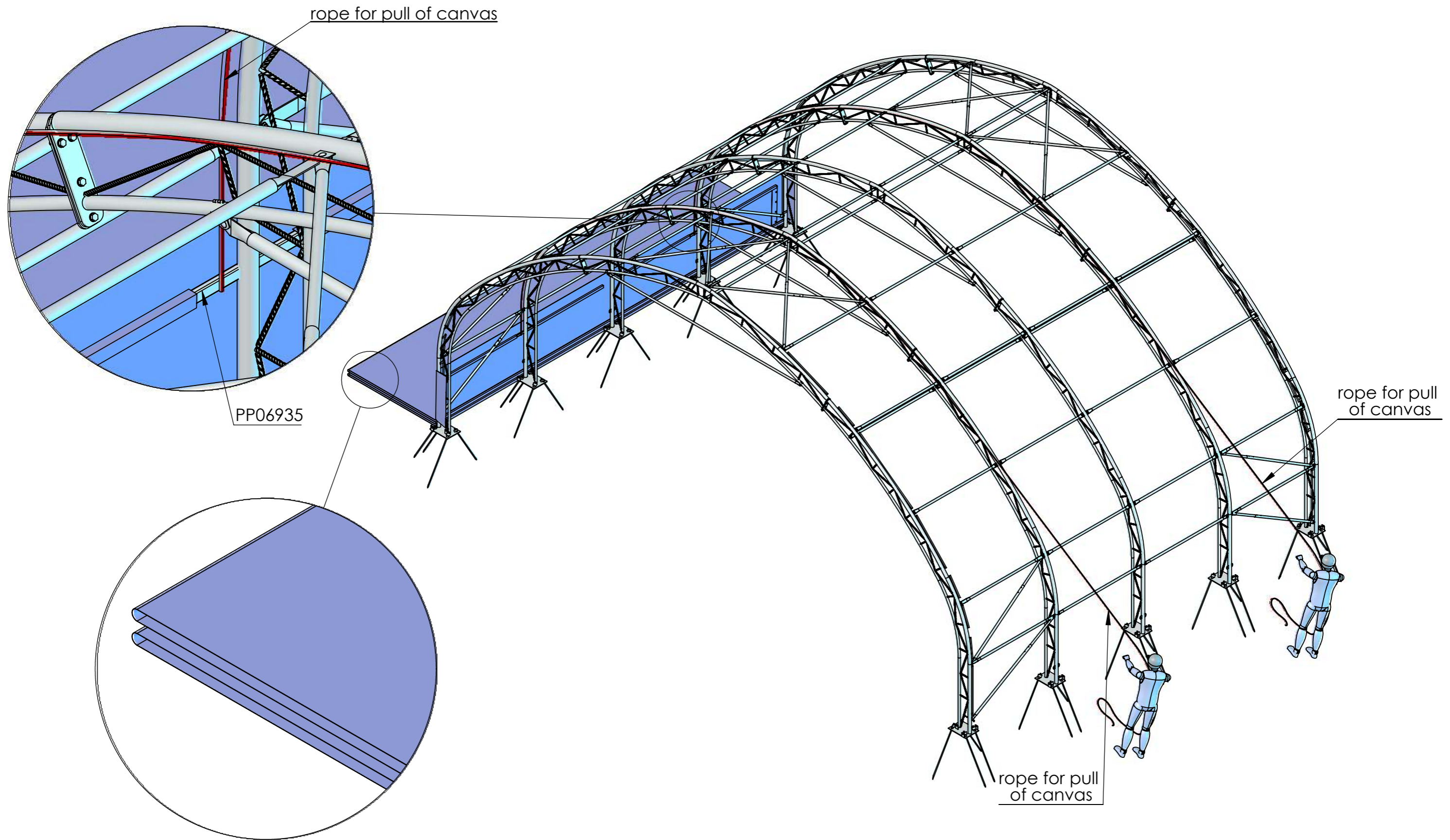

mounting instruction - pull of canvas

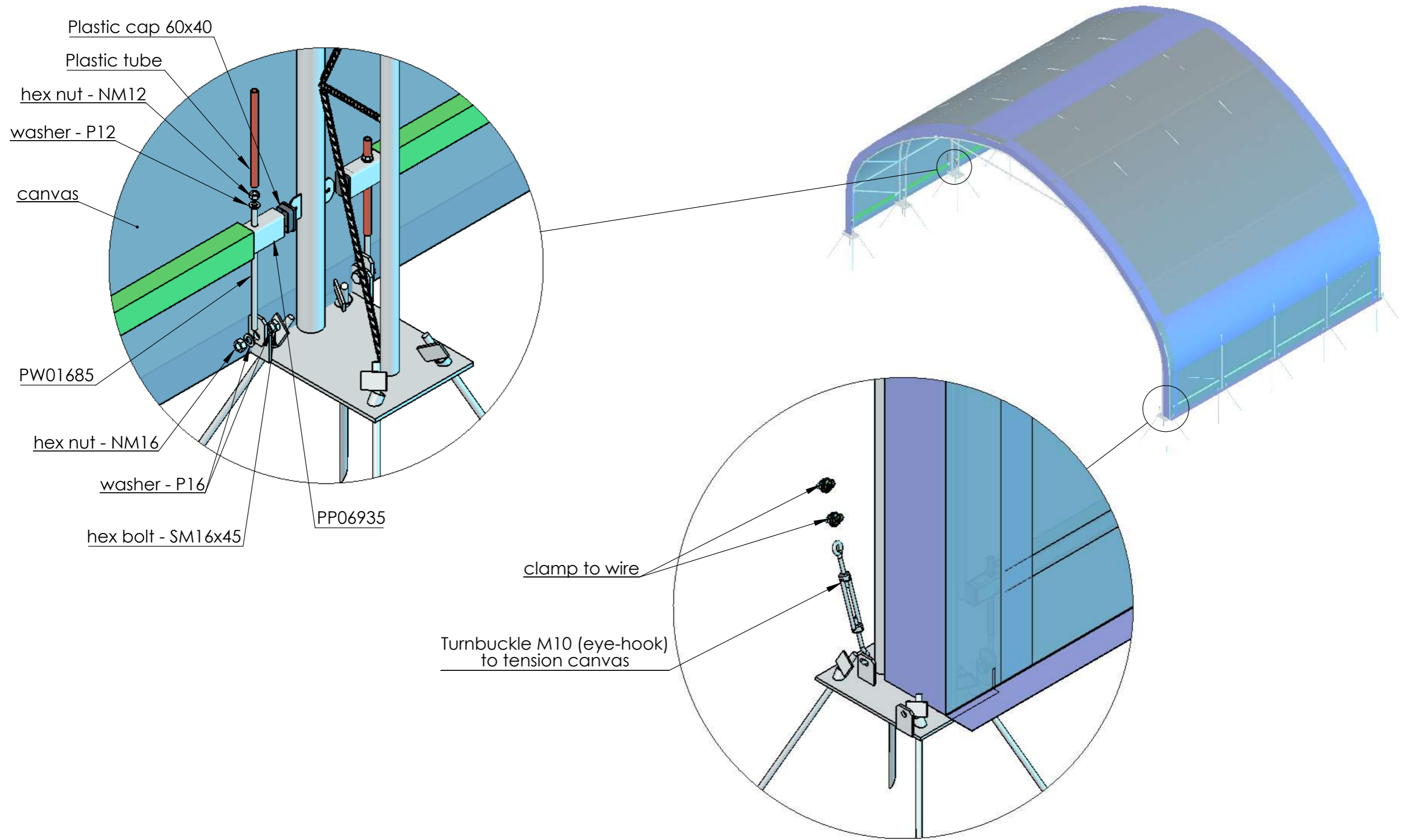

mounting instruction - tension canvas

DANCOVER[®]

.com

Contact information

Head office:

Dancover A/S
Nordre Strandvej 119 G
3150 Hellebæk
Denmark

For more information
please visit:

www.dancovershop.com

National contact

Denmark: 70 26 76 20
denmark@dancover.com

UK: 020 8099 7570
uk@dancover.com

Germany: 041 0266 7040
germany@dancover.com

France: 0975 181 800
france@dancover.com

Sweden: 040 233 262
sverige@dancover.com

Finland: 0 931 581 720
suomi@dancover.com

Poland: 22 300 8602
polska@dancover.com

Luxembourg: +49 041 0266 7040
luxembourg@dancover.com

Portugal: 308 800 899
portugal@dancover.com

Spain: 911 436 828
espana@dancover.com

Italy: 02 479 21 198
italia@dancover.com

Switzerland: 0840 000125
schweiz@dancover.com

Austria: 0662 626935
austria@dancover.com

Norway: 231 00 690
norge@dancover.com

Nederland: 0 858 880 524
nederland@dancover.com

Ireland: 0 151 33 003
ireland@dancover.com

Belgium: 0 28 08 08 09
belgique@dancover.com