

DANCOVER[®]



Manual
for
Storage Tent PRO
4m Series PVC/PE

DANCOVER[®]

.com

Safety Advice

Attention

In some countries approval is needed to set up a tent larger than 75 m². It is your responsibility to comply with local rules and regulations and to ensure that the tent is assembled correctly.

In case of bad weather conditions, it is your responsibility to ensure the tent is safely secured and that the tent does not cause damage to others.

Do not use open fire, welding equipment or other sources which can ignite, inside or close to the tent.

The tent must be safely secured. We recommend you secure your tent with straps and pegs as soon as it is assembled.

Make sure to check if the tent is covered by your home contents insurance.

Tents must be evacuated under extreme weather conditions.

In the event of snow, always remove snow from the roof of the tent regularly to prevent snow from building on the roof, as heavy snow can cause the tent to collapse.

In the event of rain, there is a risk of rain puddles building up on top of the roof of the tent. Heavy rain puddles can cause the roof to collapse. It is your responsibility to ensure rain puddles do not build up. As a precaution, make sure the roof of the tent is stretched out properly and adequately over the side frames of the tent and remove rain water regularly.

Do not unpack or repack your tent in freezing temperatures. In case of temperatures below zero, always unpack and repack your tent indoors to avoid the risk of cracking parts.

The tent must be totally dry before you repack and store it to avoid mildew.

Note: Dancover warranty applies only to the normal use of the Product, normal wear and tear excepted, in accordance with written use instructions or manual. The warranty does not apply to damage caused by accident, abuse, misuse, or modification of the Product.

Warranty Information

Please visit dancovershop.com for information on warranty.

Please always check our website for the latest safety advice and manual.

DANCOVER[®]









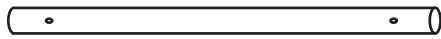
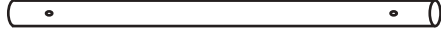

.com

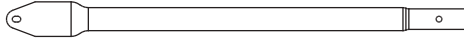

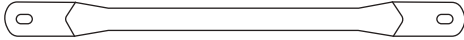
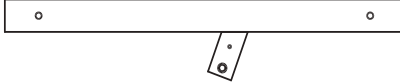
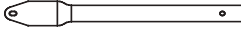
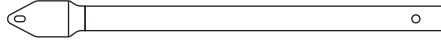

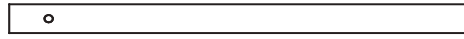
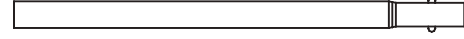
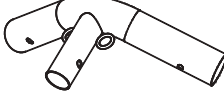
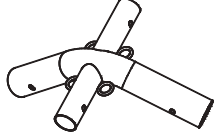

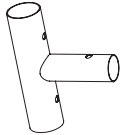
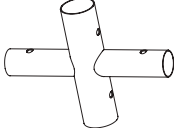
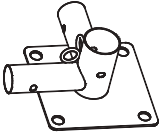
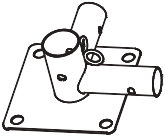
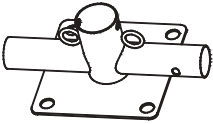
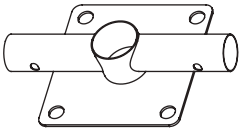
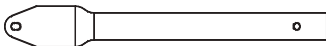
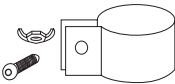
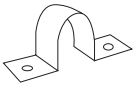

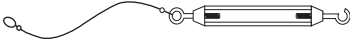
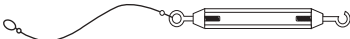
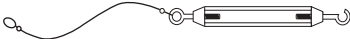





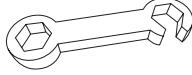

Warning

1. In order to avoid being rusted by air, oil is covered on the surface of the pipes. Before setting up the tent, please remove the oil carefully first to keep the cover clean.
2. Take note that the tent needs to be handled carefully to avoid damage.
3. Do not force the frames as they may be damage in the process.
4. Tents are meant as temporary shelter, and must be evacuated under extreme weather conditions.

Please, select a suitable site for the tent to avoid the damage of underground sprinkler systems, water, gas or electrical lines.

Part no.			4x10m	4x12m
1	Middle leg 1600mm 50-50		4	6
2	Frame pole 1880mm 38-38		39	46
3	Frame pole 1780mm 50-50		12	14
4	Frame pole 2030mm 50-50		8	10
5	Ceiling rail 2025mm 32-32		2	2
6	Diagonal support 1720mm 32-32		6	6
7	Roof support 1715mm 25-25		6	7
8	Frame pole 2030mm 50-50		4	4
9	Diagonal support 800mm 32-32		4	4
10	Female doorbar 2025mm 32-32		2	2
11	Lower leg 1600mm 50-50		8	8
12	Strengthen bar 1480mm 32-32		2	2
13	Strengthen bar 1845mm 32-32		2	2
A	3-way connector 54-42/3 rings		6	6
B	4-way connector 54-42/4 rings		12	15

Part no.			4x10m	4x12m
14	3-way connector 54-42		4	4
15	4-way connector 54-42		8	10
16	3-way connector for corner		2	2
17	3-way connector for corner		2	2
18	3-way connector for sidewall		8	10
19	2-way connector for endwall		2	2
20	Ceiling rail 1430mm 32-32		2	2
21	Bracket		12	14
22	Groundbracket		10	12
23	Strengthen bar 1855mm 25-25		20	24
24	Turnbuckle for door 5130mm		4	4
25	Turnbuckle for roof 2840mm		20	24
26	Turnbuckle for side 3870mm		20	24

Part no.			4x10m	4x12m
27	Peg 10x350mm		20	24
28	Spiral peg		4	4
29	Small peg		44	50
30	Bungeeball long		60	60
31	M6 wingnut		24	26
32	Screw M6x30mm		12	14
33	Screw M6x45mm		10	10
34	Screw M6x65mm		2	2
35	M6 nut		4	4
36	Spanner		2	2
37	Tie down		4	4
38	Steel clip		70	82
39	Screw M8x50mm		78	92
40	Screw M8x65mm		80	92
41	M8 nut		158	184
42	Peg 16x600mm		18	22
43	M12 washer		4	4

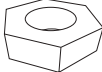
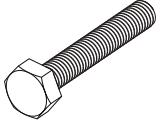
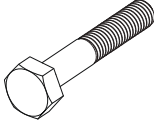
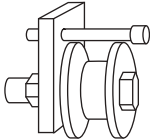
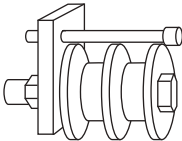
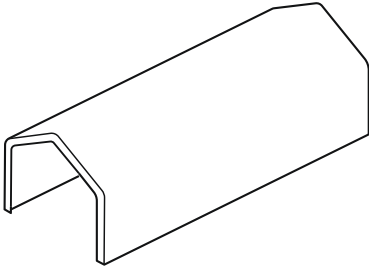
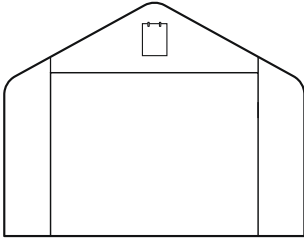
Part no.			4x10m	4x12m
44	M12 nut		4	4
45	Screw M12x48mm		2	2
46	Screw M12x65mm		2	2
47	Sheaved block 1 wheel		2	2
48	Sheaved block 2 wheel		2	2
50	Roof		1	1
51	Endwall		2	2

4x10-12x3.5m storage pro	Part 31		Part 32		Part 33	Part 34	Part 35	Part 39		Part 40		Part 41		Part 43	Part 44	Part 45	Part 46
	M6 Wing nut		M6x30 Screw		M6x45 Screw	M6x65 Screw	M6 Nut	M8x50 Screw (Ø42)		M8x65 Screw (Ø54)		M8 Nut		M12 Washer	M12 Nut	M12x48 Screw	M12x65 Screw
	4x10	4x12	4x10	4x12				4x10	4x12	4x10	4x12	4x10	4x12				
Used for Part 7 and Part 21			12	14													
Used for Part 6 and Part 20					2												
Used for Part 5 and Part 10					2												
Used for Part 6 and Part 9					4												
Used for Sheaved block 1 wheel Part 47					2		2									2	
Used for Sheaved block 2 wheel Part 48						2	2										2
Used for M6x30	12	14															
Used for M6x45	10	10															
Used for M6x65	2	2															
Used for 2-way connector 19								4	4								
Used for 3-way connector A								6	6	12	12						
Used for 4-way connector B								24	30	24	30						
Used for 3-way connector 14								4	4	8	8						
Used for 3-way connector 16								4	4	2	2						
Used for 3-way connector 17								4	4	2	2						
Used for 3-way connector 18								16	20	8	10						
Used for 4-way connector 15								16	20	16	20						
Used for Part 6 and Part 11										4	4						
Used for Part 9 and Part 11										4	4						
Used for M8x50												78	92				
Used for M8x65												80	92				
Used for M12x48														2	2		
Used for M12x65														2	2		
	24	26	12	14	10	2	4	78	92	80	92	158	184	4	4	2	2

I

Select a flat surface at ground for the tent, unpack the carton and check all the parts including tubes, tent and accessories... etc. are present and the same as the list.

Assemble the framework of rooftop by joining the portion (A, B) together with poles (2, 4, 8) NO. 11 is on four corners for diagonal pipe.

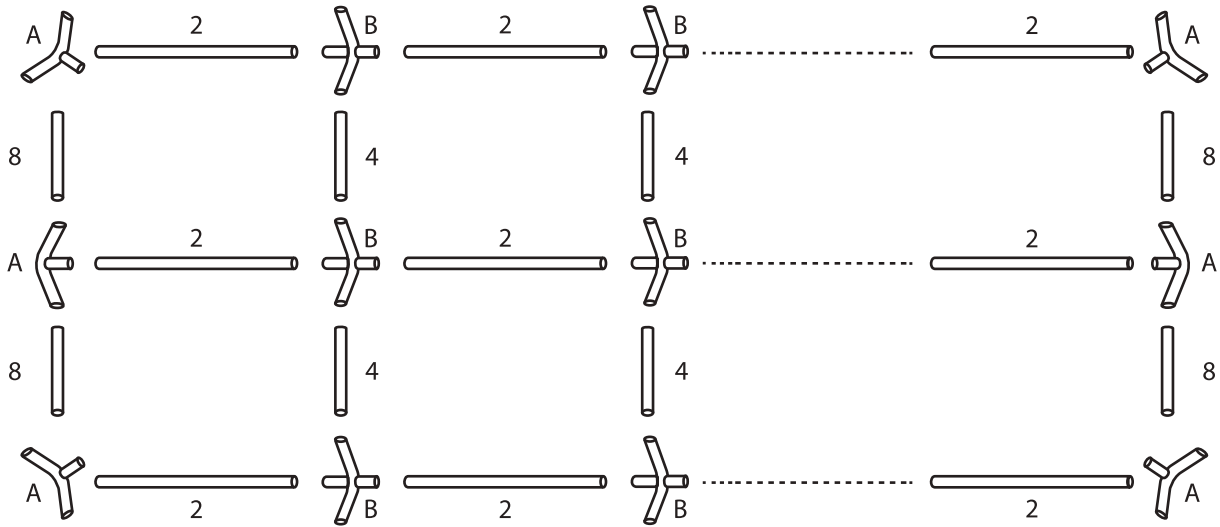

II

To ensure the screw fixed to every pole tightly. And then use the turnbuckle set which is diagonally across through each section as below.

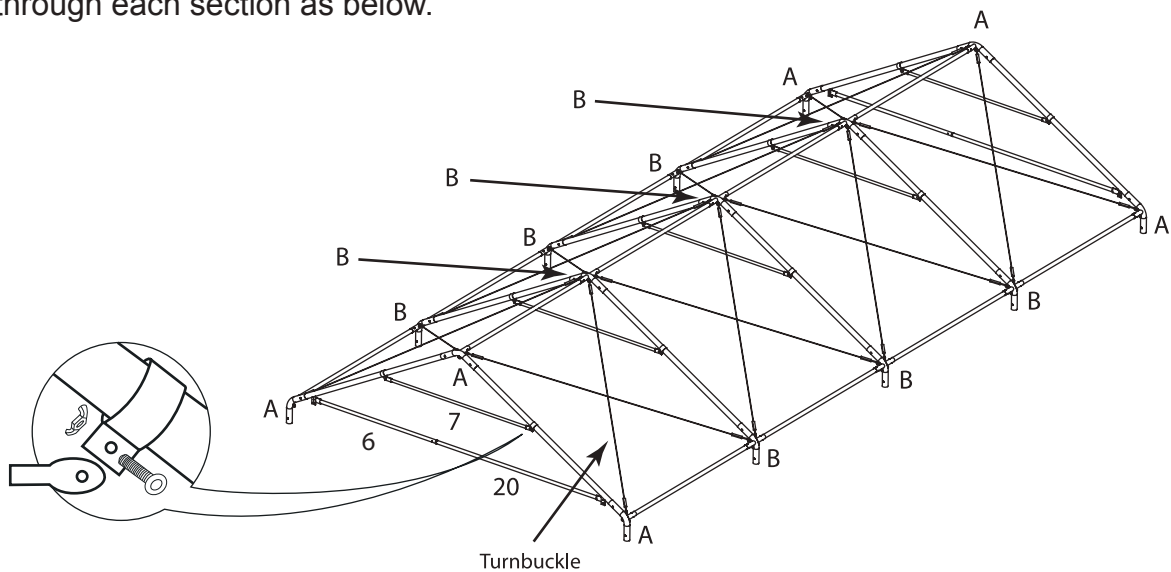

III

Attach one end of supported pole (3) to the joints.

If you want the rope pull at the opposite side than shown in the drawing then switch sheaved block (47) and (48)

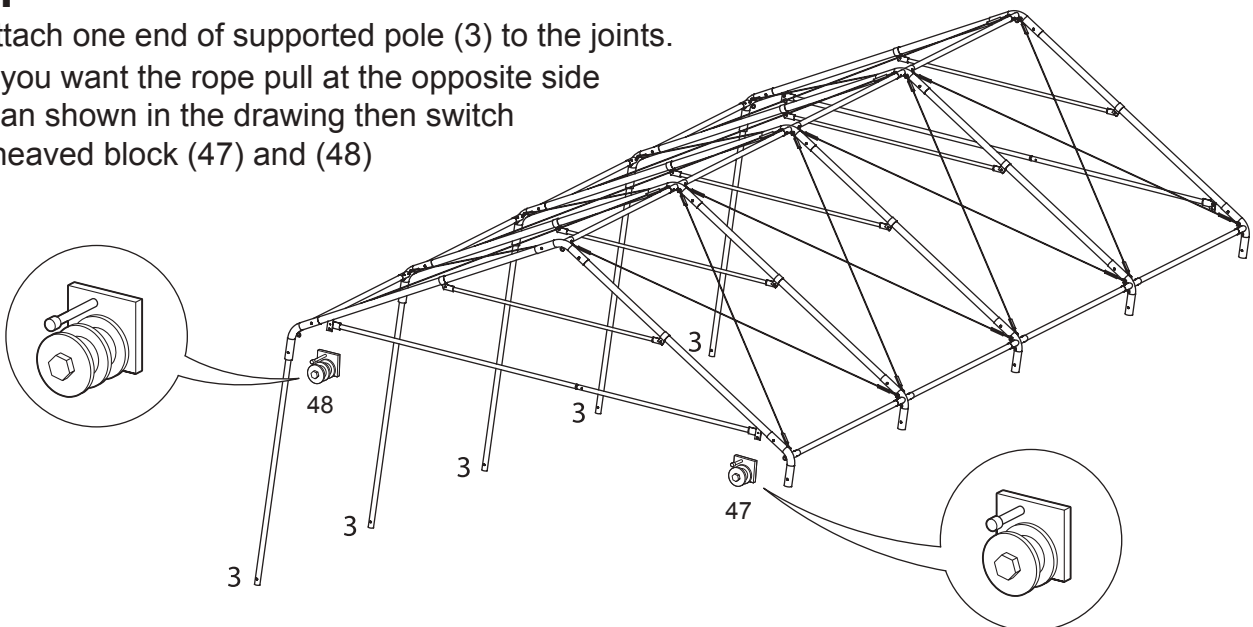

IV

Attach the other supported poles (1, 2, 11) to the joints, built-up the framework. NO. 11 is on four corners for diagonal pipe.

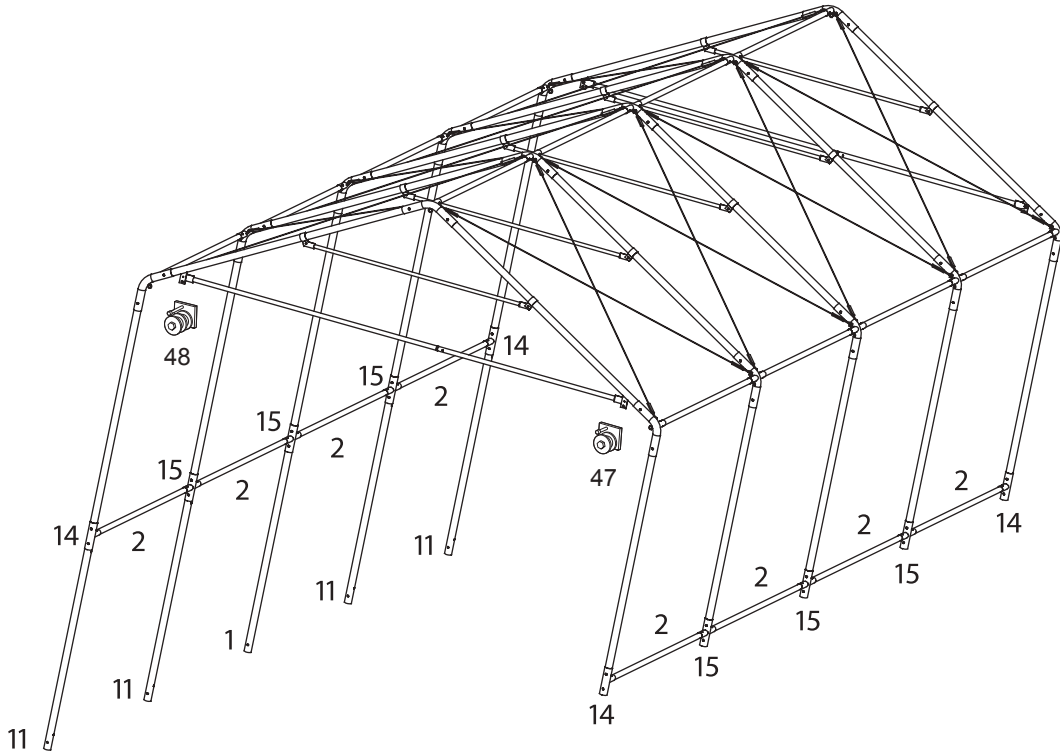

V

You facilitate the assembly and dismantling by pulling the roof with ropes on tent frame. Use the steel clips to fasten the cover to the frame. Each section we offer bracket and nail to fasten the frame to ground.

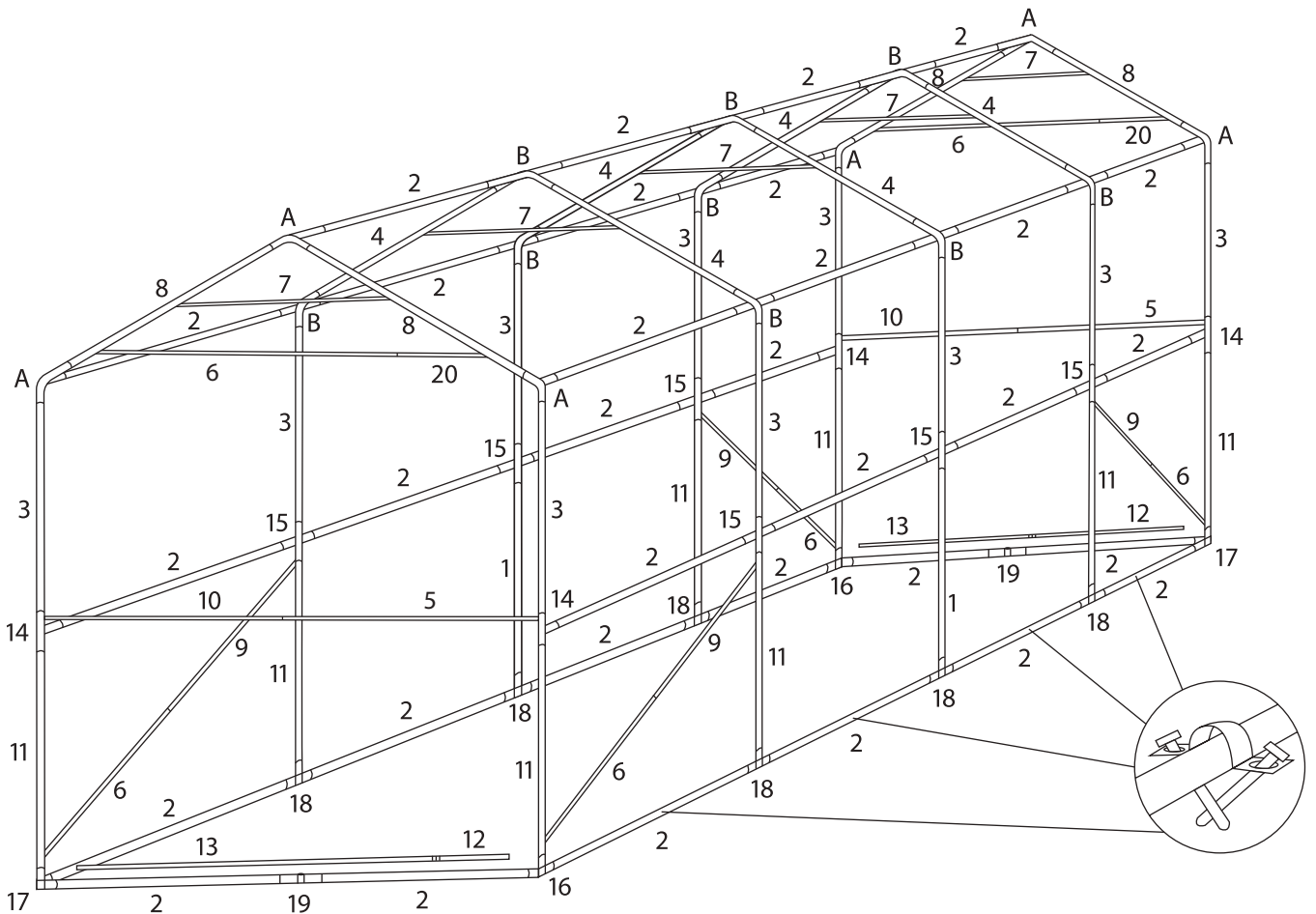

VI
Spread the wall panel and door panel attach to framework by using the bangee cords clasping the frame to grommets that is construct over the wall panel and door panel to ensure stability. Also use the short pegs to fix the doors to the ground.

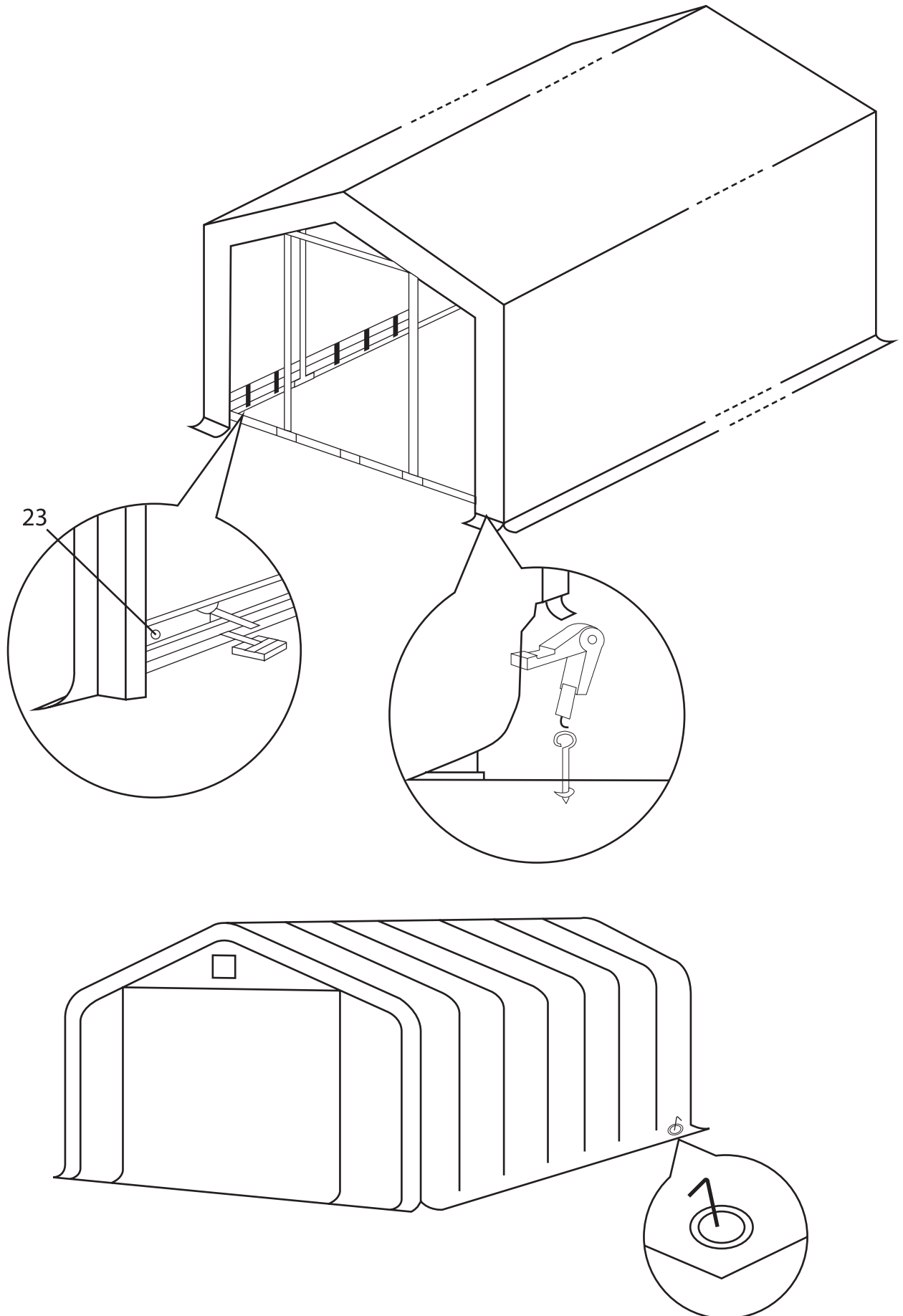

Contact information

Austria



Belgium



Croatia



Denmark



Estonia



Finland



France



Germany



Ireland



Italy



Latvia



Lithuania



Nederland



Norway



Poland



Portugal



Spain



Sweden



Switzerland



UK

