

**DANCOVER<sup>®</sup>**



Manual  
for  
Storage Tent  
6m Series PVC/PE

# DANCOVER<sup>®</sup>

.com

## Safety Advice

### Attention

In some countries approval is needed to set up a tent larger than 75 m<sup>2</sup>. It is your responsibility to comply with local rules and regulations and to ensure that the tent is assembled correctly.

In case of bad weather conditions, it is your responsibility to ensure the tent is safely secured and that the tent does not cause damage to others.

Do not use open fire, welding equipment or other sources which can ignite, inside or close to the tent.

The tent must be safely secured. We recommend you secure your tent with straps and pegs as soon as it is assembled.

Make sure to check if the tent is covered by your home contents insurance.

Tents must be evacuated under extreme weather conditions.

In the event of snow, always remove snow from the roof of the tent regularly to prevent snow from building on the roof, as heavy snow can cause the tent to collapse.

In the event of rain, there is a risk of rain puddles building up on top of the roof of the tent. Heavy rain puddles can cause the roof to collapse. It is your responsibility to ensure rain puddles do not build up. As a precaution, make sure the roof of the tent is stretched out properly and adequately over the side frames of the tent and remove rain water regularly.

Do not unpack or repack your tent in freezing temperatures. In case of temperatures below zero, always unpack and repack your tent indoors to avoid the risk of cracking parts.

The tent must be totally dry before you repack and store it to avoid mildew.













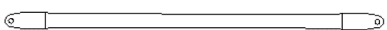
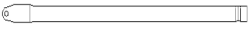

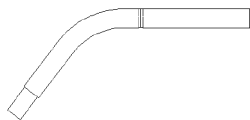
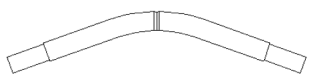
**Note:** Dancover warranty applies only to the normal use of the Product, normal wear and tear excepted, in accordance with written use instructions or manual. The warranty does not apply to damage caused by accident, abuse, misuse, or modification of the Product.







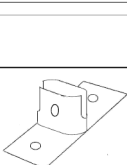
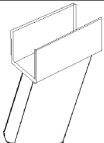



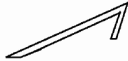

## Warranty Information

Please visit [dancovershop.com](http://dancovershop.com) for information on warranty.

*Please always check our website for the latest safety advice and manual.*

# Part list

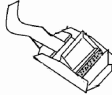
|    |                      |   | 6x6 | 6x12 | 6x18 |
|----|----------------------|---|-----|------|------|
| 1  | Back leg             |    | 4   | 6    | 8    |
| 2  | Back leg             |    | 8   | 16   | 24   |
| 3  | Crossbar             |    | 8   | 16   | 24   |
| 4  | Ceiling rail         |    | 6   | 11   | 16   |
| 5  | Ceiling rail         |    | 6   | 11   | 16   |
| 6  | Extension pipe       |    | 4   | 4    | 4    |
| 7  | Corner arch          |    | 12  | 22   | 32   |
| 8  | Center arch          |    | 6   | 11   | 16   |
| 9  | Connecting pipe      |    | 44  | 99   | 154  |
| 10 | Connecting pipe      |  | 11  | 11   | 11   |
| 11 | Extension pipe       |  | 8   | 18   | 28   |
| 12 | Door Pillar          |  | 4   | 4    | 4    |
| 13 | Door pillar          |  | 4   | 4    | 4    |
| 14 | Cross bar            |  | 8   | 8    | 8    |
| 15 | Fastening bar        |  | 10  | 20   | 30   |
| 16 | Foot base            |  | 16  | 26   | 36   |
| 17 | Connecting component |  | 4   | 4    | 4    |
| 18 | Peg<br>10x305mm      |  | 8   | 16   | 24   |

|    |                                 |   |    |     |     |
|----|---------------------------------|---|----|-----|-----|
| 19 | Peg<br>6x180mm                  |    | 34 | 60  | 78  |
| 20 | Peg<br>8x300mm                  |    | 24 | 44  | 64  |
| 21 | Spiral peg<br>10x400mm          |    | 4  | 4   | 4   |
| 22 | 1.75" Screw                     |    | 6  | 11  | 16  |
| 23 | 2.5" Screw                      |    | 12 | 22  | 32  |
| 24 | 4" Screw                        |    | 70 | 124 | 180 |
| 25 | Wingnut                         |    | 88 | 157 | 228 |
| 26 | Floor Bracket<br>(set of 2 pcs) |   | 4  | 8   | 12  |
| 27 | Bungee ball                     |  | 96 | 96  | 96  |
| 28 | Spanner                         |  | 2  | 2   | 2   |
| 29 | Bolt with nut                   |  | 16 | 26  | 36  |
| 30 | Tie-down kit                    |  | 4  | 4   | 4   |
| 31 | Steel clip                      |  | 20 | 40  | 60  |
| 32 | Rope                            |  | 4  | 4   | 4   |
| 33 | Rope                            |  | 2  | 2   | 2   |

20-08-2021

## Attention

Please use gloves when assembling the metal frame portion of this unit. The metal components of this products have been treated,with a rust preventive coating that may feel oily to the touch. This coating is not dangerous, but may dirty your hands during assembly. We recommend that you wipe the metal parts clean with a mixture of warm water and dish detergent prior to assembly. Should your hands become dirty, simply wash with soap and water.

| 6m storage pro               | Part 22     |      |      | Part 23     |      |      | Part 24      |      |      | Part 25     |      |      | Part 29             |      |      |
|------------------------------|-------------|------|------|-------------|------|------|--------------|------|------|-------------|------|------|---------------------|------|------|
|                              | M6x45 Screw |      |      | M6x65 Screw |      |      | M6x105 Screw |      |      | M6 Wing nut |      |      | M8x55 Bolt with nut |      |      |
|                              | 6x6         | 6x12 | 6x18 | 6x6         | 6x12 | 6x18 | 6x6          | 6x12 | 6x18 | 6x6         | 6x12 | 6x18 | 6x6                 | 6x12 | 6x18 |
| Used for Part 4 and Part 5   | 6           | 11   | 16   |             |      |      |              |      |      | 6           | 11   | 16   |                     |      |      |
| Used for Part 4 and Part 6   |             |      |      | 2           | 2    | 2    |              |      |      | 2           | 2    | 2    |                     |      |      |
| Used for Part 5 and Part 6   |             |      |      | 2           | 2    | 2    |              |      |      | 2           | 2    | 2    |                     |      |      |
| Used for Part 4 and Part 11  |             |      |      | 4           | 9    | 14   |              |      |      | 4           | 9    | 14   |                     |      |      |
| Used for Part 5 and Part 11  |             |      |      | 4           | 9    | 14   |              |      |      | 4           | 9    | 14   |                     |      |      |
| Used for Part 1 and Part 14  |             |      |      | 4           | 4    | 4    |              |      |      | 4           | 4    | 4    |                     |      |      |
| Used for Part 12 and Part 14 |             |      |      | 4           | 4    | 4    |              |      |      | 4           | 4    | 4    |                     |      |      |
| Used for Part 1 and Part 10  |             |      |      |             |      |      | 4            | 4    | 4    | 4           | 4    | 4    |                     |      |      |
| Used for Part 1 and Part 9   |             |      |      |             |      |      | 4            | 4    | 4    | 4           | 4    | 4    |                     |      |      |
| Used for Part 7 and Part 10  |             |      |      |             |      |      | 2            | 2    | 2    | 2           | 2    | 2    |                     |      |      |
| Used for Part 6 and Part 10  |             |      |      |             |      |      | 4            | 4    | 4    | 4           | 4    | 4    |                     |      |      |
| Used for Part 8 and Part 10  |             |      |      |             |      |      | 1            | 1    | 1    | 1           | 1    | 1    |                     |      |      |
| Used for Part 2 and Part 9   |             |      |      |             |      |      | 16           | 36   | 56   | 16          | 36   | 56   |                     |      |      |
| Used for Part 7 and Part 9   |             |      |      |             |      |      | 10           | 20   | 30   | 10          | 20   | 30   |                     |      |      |
| Used for Part 8 and Part 9   |             |      |      |             |      |      | 5            | 10   | 15   | 5           | 10   | 15   |                     |      |      |
| Used for Part 11 and Part 9  |             |      |      |             |      |      | 16           | 36   | 56   | 16          | 36   | 56   |                     |      |      |
| Used for Part 6 and Part 9   |             |      |      |             |      |      | 4            | 4    | 4    | 4           | 4    | 4    |                     |      |      |
| Used for Part 1 and Part 16  |             |      |      |             |      |      |              |      |      |             |      |      | 4                   | 4    | 4    |
| Used for Part 2 and Part 16  |             |      |      |             |      |      |              |      |      |             |      |      | 8                   | 18   | 28   |
| Used for Part 13 and Part 14 |             |      |      |             |      |      |              |      |      |             |      |      | 4                   | 4    | 4    |
| Used for Part 12 and Part 17 |             |      |      |             |      |      |              |      |      |             |      |      | 4                   | 4    | 4    |
| Used for endwall             |             |      |      |             |      |      |              |      |      |             |      |      |                     |      |      |
|                              | 6           | 11   | 16   | 20          | 30   | 40   | 66           | 121  | 176  | 92          | 162  | 232  | 20                  | 30   | 40   |

After the whole frames are set up, they should be the same as the pictures below.

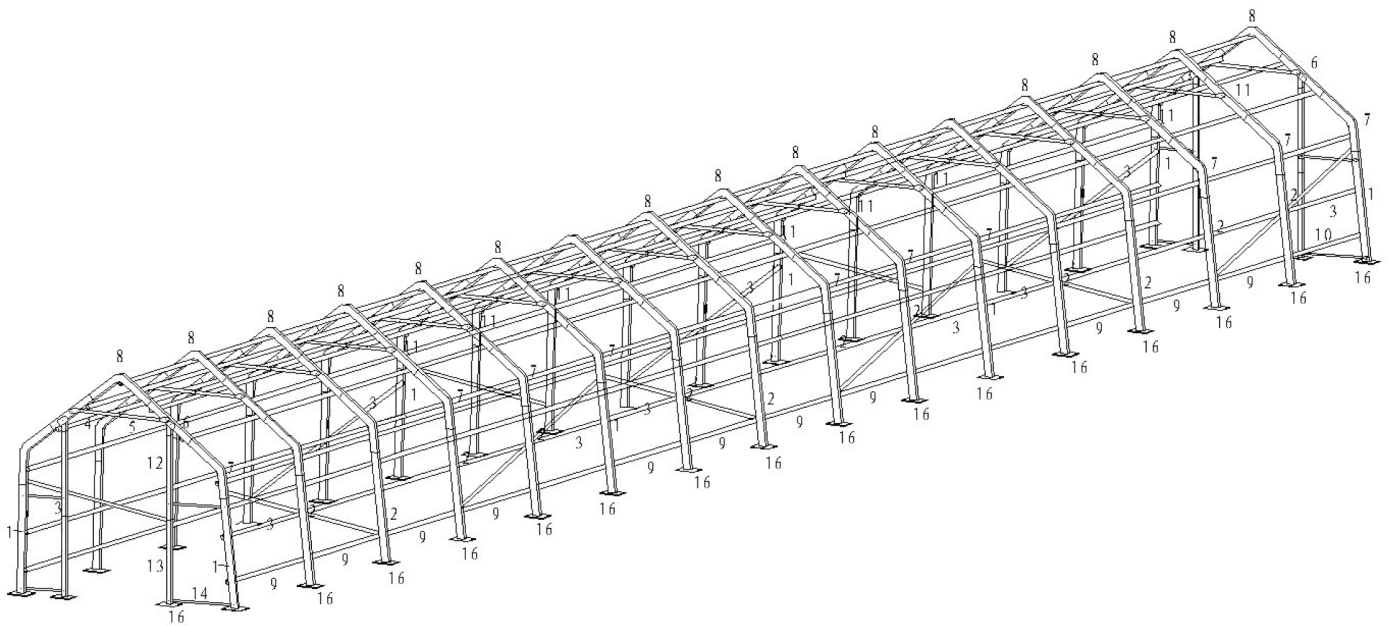
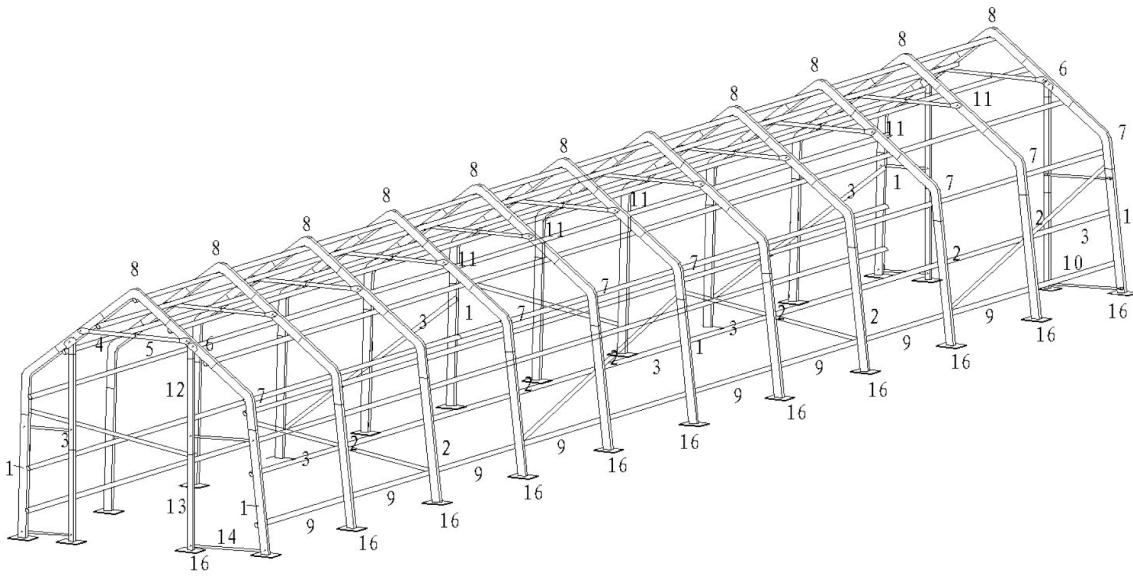
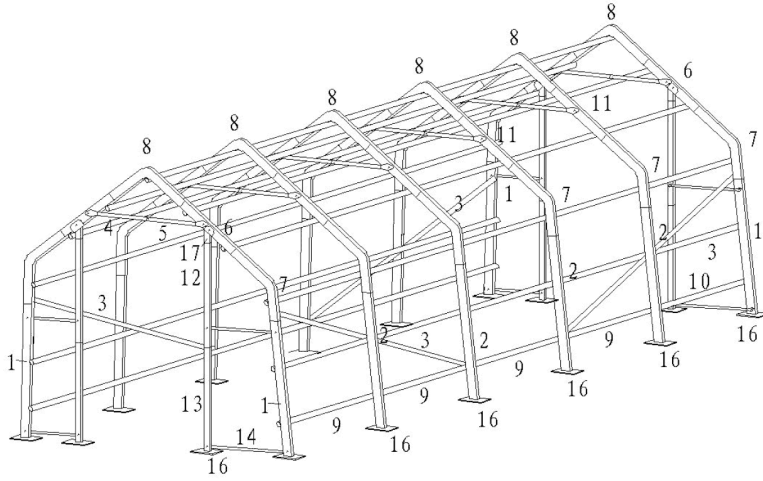

Please assemble the frame as below steps. They have similar assemble steps. Here we take 6x6 for example .

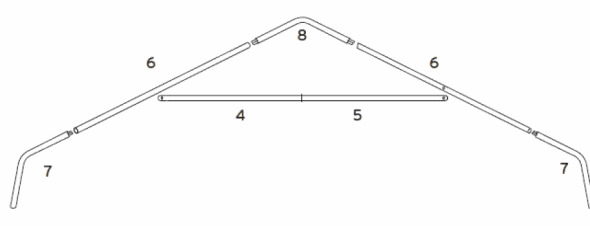
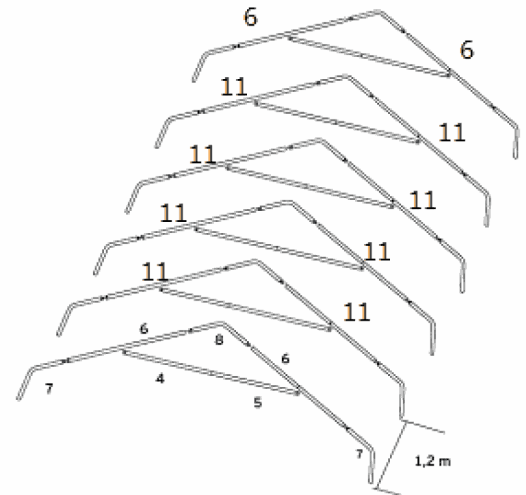
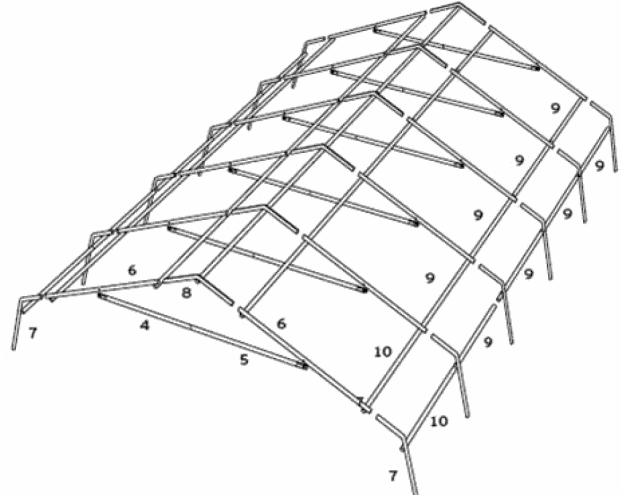
|   |  |
|---|--|
| <p><b>Step 1</b><br/>         When assembling the tent, make sure that all the wingnuts are attached to the inside.<br/>         Connect one center arch pipe(8) with the extension pipe Attached the corner arch(7) to the ends of the extension pipe(6). Now connect the ceiling rail(4 and 5) with each other using the 1.75"(22) screw and the wingnuts(25). Connect the ceiling rail with respective extension pipe(6) using the 2.5"(23) screws and wingnuts(25).</p> |    |
| <p><b>Step 2</b><br/>         Repeat step 1 for the next 5/10/15 elements to place them on the ground one after another, as illustrated.<br/><br/>         Attention: all elements with extension pipe no.6 need to be placed at the ends. Extension pipe no.6 has holes for door pillar.</p>   |   |
| <p><b>Step 3</b><br/>         Now connect the 6 arch elements with each other using the connecting pipes (9 and 10). Not that only corner arch 10 are used for the front segments. Use the 4"(24) screw and wingnut(25) to tighten them.</p>  |  |

#### Step 4

Start setting up one side first. Connect the corner arches(7) to the legs (1 and 2). Secure the frame using the connecting pipes(9 and 10). Attach the diagonal pipes(3) to the back legs(1). Please refer to the complete frame pictures to attach the diagonal pipes.

Tighten the tent at the feet using the 4" screws(24) and the wingnuts(25).

Use the floor bracket(26) and the pegs 10x305mm(18) to fasten the frame to the ground.

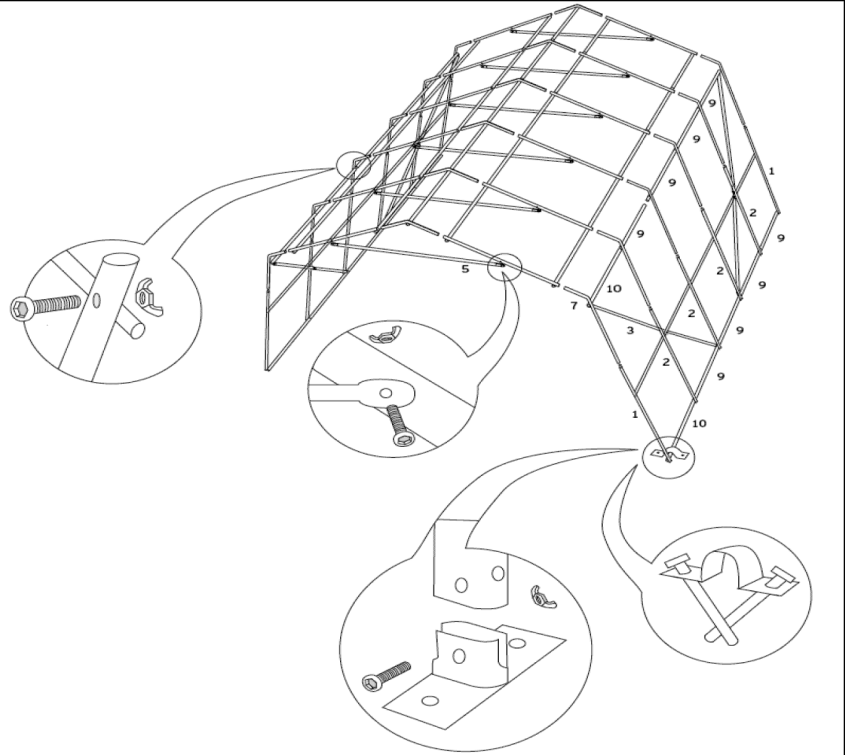

#### Step 5

Unfold the tent cover and put it over the frame. Insert the fastening bar into the loop at the lower end of the rood and fasten it with steel clips(31). Attach the endwall to the fram using the bungees. Tension the roof cover to the tent frame to the ground using pegs 8x300mm(20)

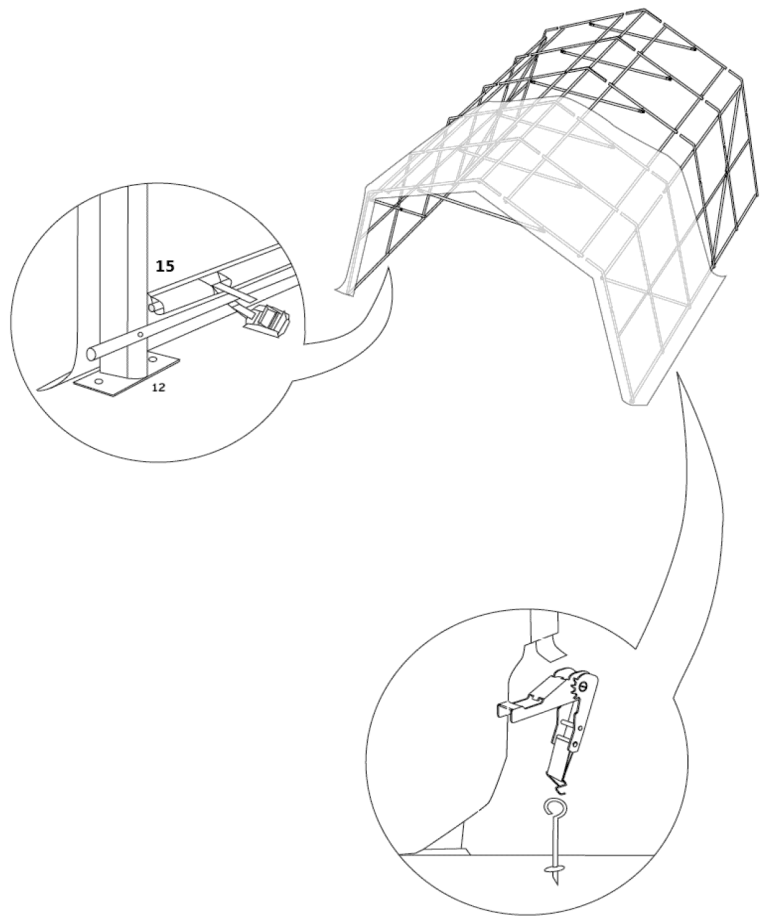



Step 6

Assemble the pillar set like below picture .

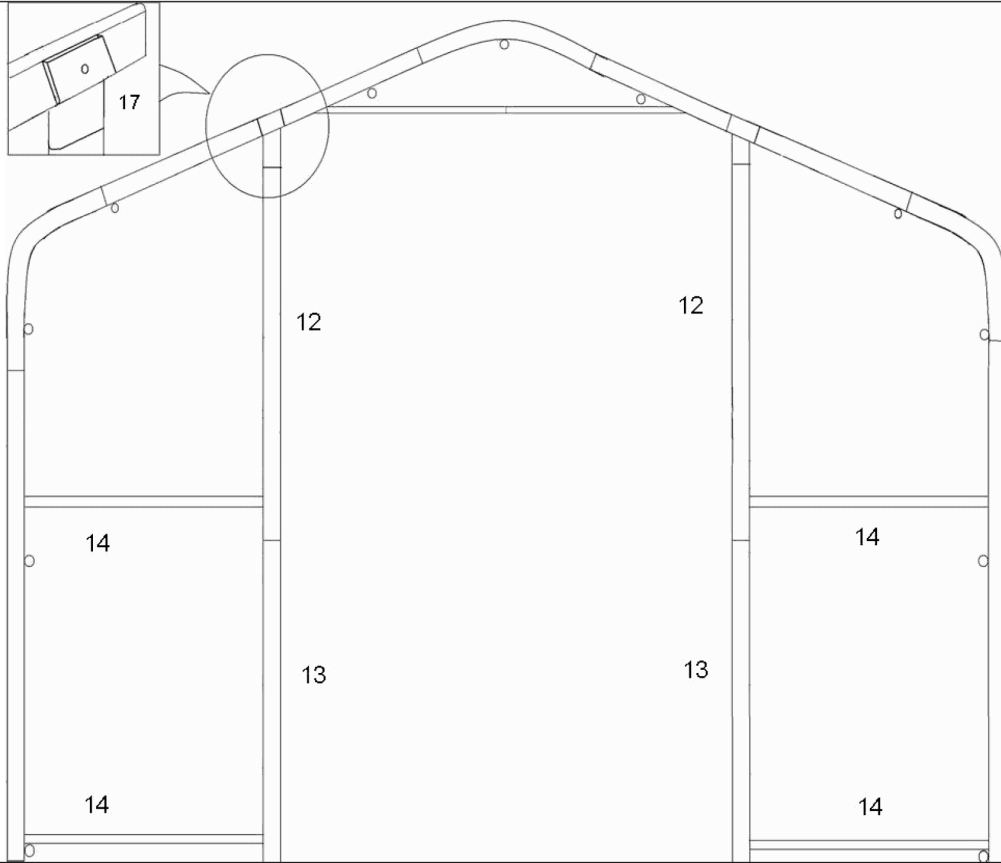

Step 7

Use ropes to attach the door and cover the the frame. To find a proper way and strength to attach the cover to frame carefully. Please do not use too much strength to tear the eyelet out of fabric

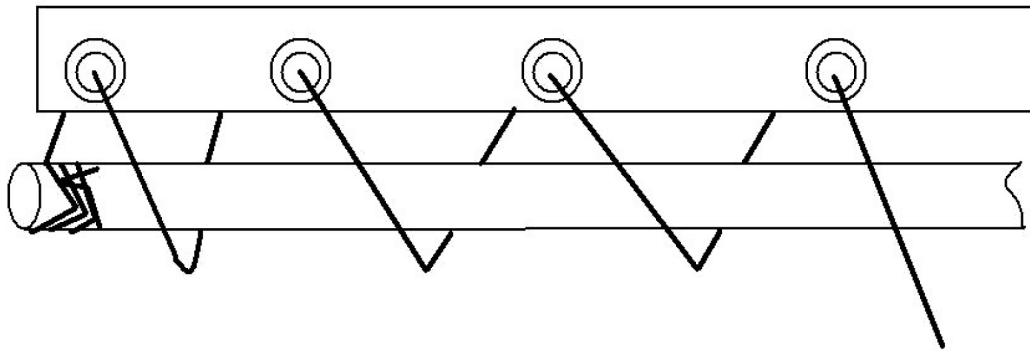

## Contact information

Head office:

Dancover A/S  
Lyngevej 16A, Nørre Herlev  
3400 Hillerød  
Denmark

For more information  
please visit:  
[www.dancovershop.com](http://www.dancovershop.com)

## National contact

Denmark:

[denmark@dancover.com](mailto:denmark@dancover.com)

UK:

[uk@dancover.com](mailto:uk@dancover.com)

Germany:

[germany@dancover.com](mailto:germany@dancover.com)

France:

[france@dancover.com](mailto:france@dancover.com)

Sweden:

[sverige@dancover.com](mailto:sverige@dancover.com)

Finland:

[suomi@dancover.com](mailto:suomi@dancover.com)

Poland:

[polska@dancover.com](mailto:polska@dancover.com)

Luxembourg:

[luxembourg@dancover.com](mailto:luxembourg@dancover.com)

Portugal:

[portugal@dancover.com](mailto:portugal@dancover.com)

Spain:

[espana@dancover.com](mailto:espana@dancover.com)

Italy:

[italia@dancover.com](mailto:italia@dancover.com)

Switzerland:

[schweiz@dancover.com](mailto:schweiz@dancover.com)

Austria:

[austria@dancover.com](mailto:austria@dancover.com)

Norway:

[norge@dancover.com](mailto:norge@dancover.com)

Nederland:

[nederland@dancover.com](mailto:nederland@dancover.com)

Ireland:

[ireland@dancover.com](mailto:ireland@dancover.com)

Belgium:

[belgique@dancover.com](mailto:belgique@dancover.com)