

DANCOVER[®]



Manual
for
Storage Tent
5m Series PVC/PE

DANCOVER[®]

.com

Safety Advice

Attention

In some countries approval is needed to set up a tent larger than 75 m². It is your responsibility to comply with local rules and regulations and to ensure that the tent is assembled correctly.

In case of bad weather conditions, it is your responsibility to ensure the tent is safely secured and that the tent does not cause damage to others.

Do not use open fire, welding equipment or other sources which can ignite, inside or close to the tent.

The tent must be safely secured. We recommend you secure your tent with straps and pegs as soon as it is assembled.

Make sure to check if the tent is covered by your home contents insurance.

Tents must be evacuated under extreme weather conditions.

In the event of snow, always remove snow from the roof of the tent regularly to prevent snow from building on the roof, as heavy snow can cause the tent to collapse.

In the event of rain, there is a risk of rain puddles building up on top of the roof of the tent. Heavy rain puddles can cause the roof to collapse. It is your responsibility to ensure rain puddles do not build up. As a precaution, make sure the roof of the tent is stretched out properly and adequately over the side frames of the tent and remove rain water regularly.

Do not unpack or repack your tent in freezing temperatures. In case of temperatures below zero, always unpack and repack your tent indoors to avoid the risk of cracking parts.

The tent must be totally dry before you repack and store it to avoid mildew.

Note: Dancover warranty applies only to the normal use of the Product, normal wear and tear excepted, in accordance with written use instructions or manual. The warranty does not apply to damage caused by accident, abuse, misuse, or modification of the Product.

Warranty Information

Please visit dancovershop.com for information on warranty.











Please always check our website for the latest safety advice and manual.

Warning



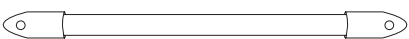
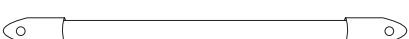
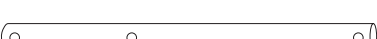
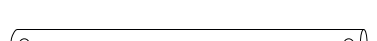



1. In order to avoid being rusted by air, oil is covered on the surface of the pipes, before setting up the tent, please remove the oil carefully first to keep the cover clean.
2. Take note that the tent needs to be handled carefully to avoid damage.
3. Do not force the frame as it might get damaged in the process.
4. Tents are meant as temporary shelter and must be evacuated under extreme weather conditions.

Please select a suitable site for the tent to avoid any damage to underground sprinkler systems, water, gas or electrical lines.

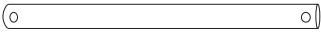
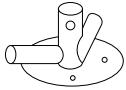
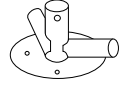
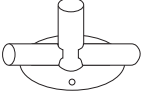
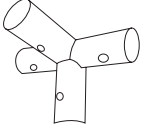
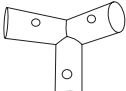

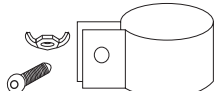
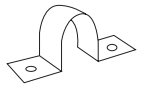





5m Storage tent manual

Part No.			5x4m	5x6m	5x8m	5x10m	5x12m
1	Middle leg 1880mm Ø50		2	4	6	8	10
2	Frame pole 1880mm Ø38		6	11	16	21	26
3-1	Frame pole 1880mm Ø38		2	2	2	2	2
3-2	Frame pole 1880mm Ø38		2	2	2	2	2
4	Frame pole 1880mm Ø50		6	8	10	12	14
5	Frame pole 780mm Ø50		6	8	10	12	14
6	Diagonal support 1158mm Ø25		4	4	4	4	4
7	Roof support 1720mm Ø25		3	4	5	6	7
8	Corner leg 1880mm Ø50		4	4	4	4	4
9	Female doorbar Ø38		2	2	2	2	2
10	Male doorbar Ø38		2	2	2	2	2
11	Pillar 1270mm Ø50		4	4	4	4	4
12	Pillar Ø50		4	4	4	4	4
13	Ceiling rail Ø25		2	2	2	2	2

5m Storage tent manual

Part No.			5x4m	5x6m	5x8m	5x10m	5x12m
14	Ceiling rail Ø25		2	2	2	2	2
15	Groundbar pipe Ø38		4	4	4	4	4
16	3-way connector for corner 54-42mm		2	2	2	2	2
17	3-way connector for corner 54-42mm		2	2	2	2	2
18	3-way connector for sidewall 54-42mm		6	8	10	12	14
B	4-way connector 120° 54-42mm		3	6	9	12	15
A	3-way connector 120° 54-42mm		6	6	6	6	6
23	Strengthen bar for roof cover		4	6	8	10	12
24	Bracket Ø50		10	12	14	16	18
25	Groundbracket Ø38		4	6	8	10	12
26	Peg 345mm		8	12	16	20	24
27	Spiral peg		4	4	4	4	4
28	Long peg		10	12	14	16	18
29	Small peg		28	32	36	40	44

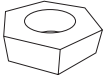
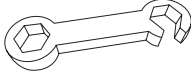
5m Storage tent manual

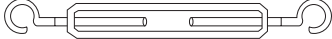
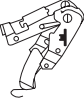
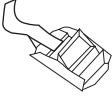
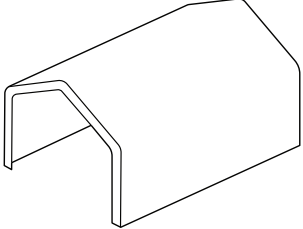
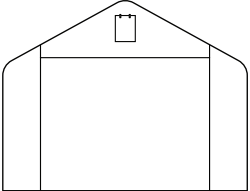
Part No.			5x4m	5x6m	5x8m	5x10m	5x12m
30	Bungeeball long		44	44	44	44	44
31	Rope		4	4	4	4	4
32	Screw M6x30mm		12	14	16	18	20
35	M6 wingnut		12	14	16	18	20
37	Screw M8x50mm		38	48	58	68	78
38	Screw M8x60mm		42	52	62	72	82
39	M8 nut		80	100	120	140	160
40	Spanner		1	1	1	1	1
41	Steel tension bar		8	12	16	20	24
42	Turnbuckle		4	6	8	10	12
43	Tie down		4	4	4	4	4
44	Steel clip		16	20	24	28	32
45	Roof		1	1	1	1	1
46	Endwall		2	2	2	2	2

5m storage pro	Part 32					Part 35					Part 37					Part 38					Part 39				
	M6x30 Screw					M6 Wing nut					M8x50 Screw (Ø42)					M8x60 Screw (Ø54)					M8 Nut				
	5x4	5x6	5x8	5x10	5x12	5x4	5x6	5x8	5x10	5x12	5x4	5x6	5x8	5x10	5x12	5x4	5x6	5x8	5x10	5x12	5x4	5x6	5x8	5x10	5x12
Used for Part 4 and Part 7	6	8	10	12	14																				
Used for Part 13 and Part 14	2	2	2	2	2																				
Used for Part 12 and Part 13	2	2	2	2	2																				
Used for Part 12 and Part 14	2	2	2	2	2																				
Used for Part 3-1 and Part 6											2	2	2	2	2										
Used for Part 3-2 and Part 6											2	2	2	2	2										
Used for Part 4 and Part 5																6	8	10	12	14					
Used for Part 6 and Part 8																4	4	4	4	4					
Used for Part 9 and Part 10											2	2	2	2	2										
Used for Part 11 and Part 12																4	4	4	4	4					
Used for 3-way connector A											6	6	6	6	6	12	12	12	12	12					
Used for 4-way connector B											6	12	18	24	30	6	12	18	24	30					
Used for 3-way connector 16											4	4	4	4	4	2	2	2	2	2					
Used for 3-way connector 17											4	4	4	4	4	2	2	2	2	2					
Used for 3-way connector 18											12	16	20	24	28	6	8	10	12	14					
Used for M6x30						12	14	16	18	20															
Used for M8x50																					38	48	58	68	78
Used for M8x65																					42	52	62	72	82
	12	14	16	18	20	12	14	16	18	20	38	48	58	68	78	42	52	62	72	82	80	100	120	140	160

I

Select a flat surface at ground for the tent, unpack the carton and check all the parts including tubes, tent and accessories... etc. are present and the same as the list.

Assemble the framework of rooftop by joining the portion (A,B) together with poles (2, 3-1, 3-2, 4, 5)
NO. 3 is on four corners for diagonal pipe. Attach part no. 24 to part no. 4 before adding part no. 7.

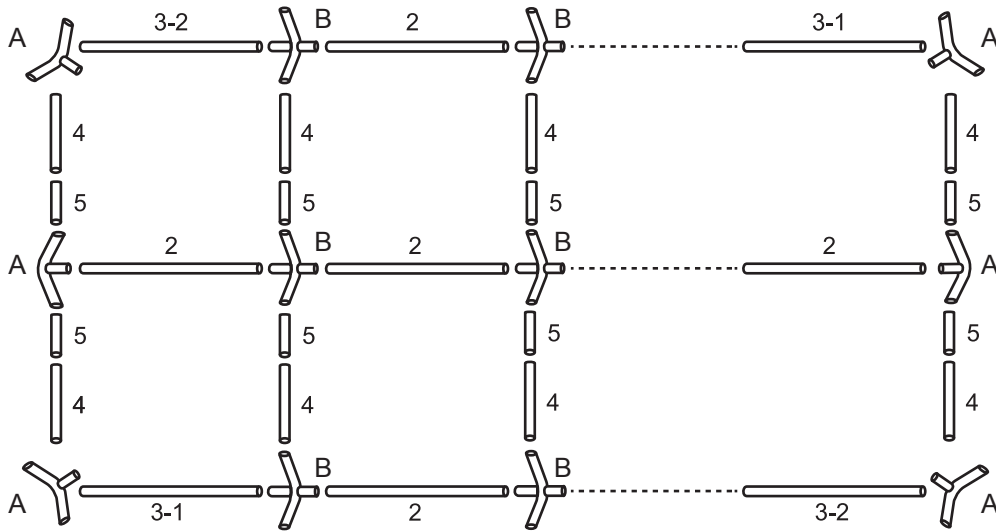

II

To ensure the screw fixed to every pole tightly. And then use the turnbuckle and steel tension bar to tighten the top structure.

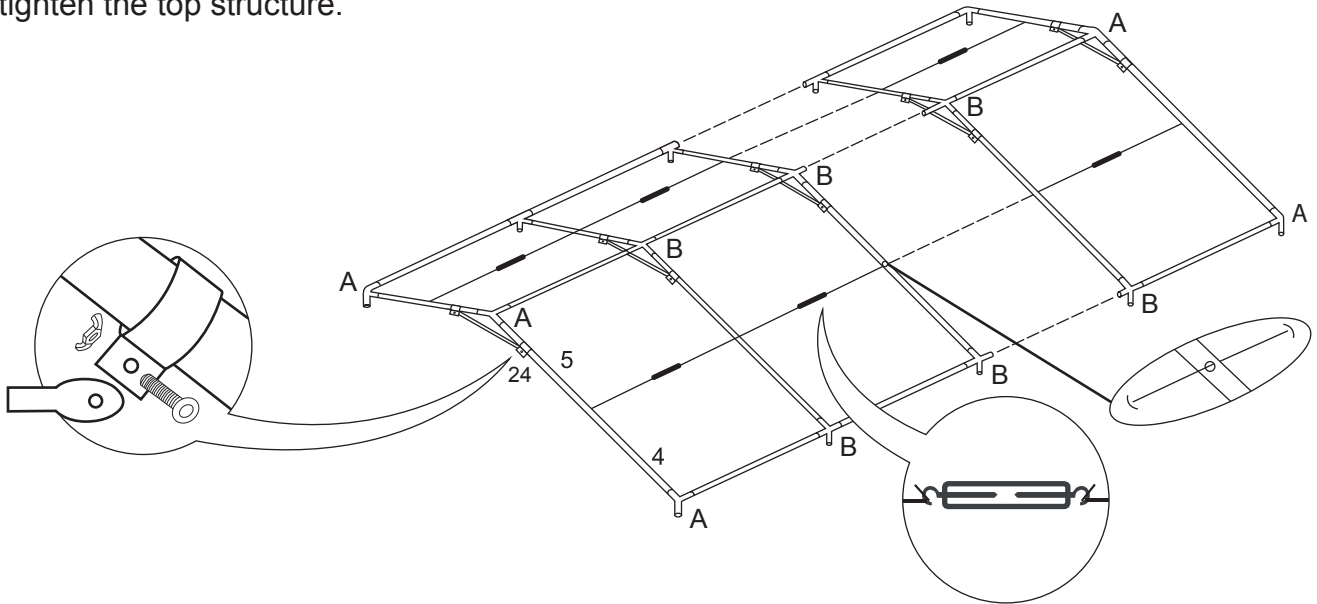

III

Attach one end of supported pole (1, 8) to the joints.

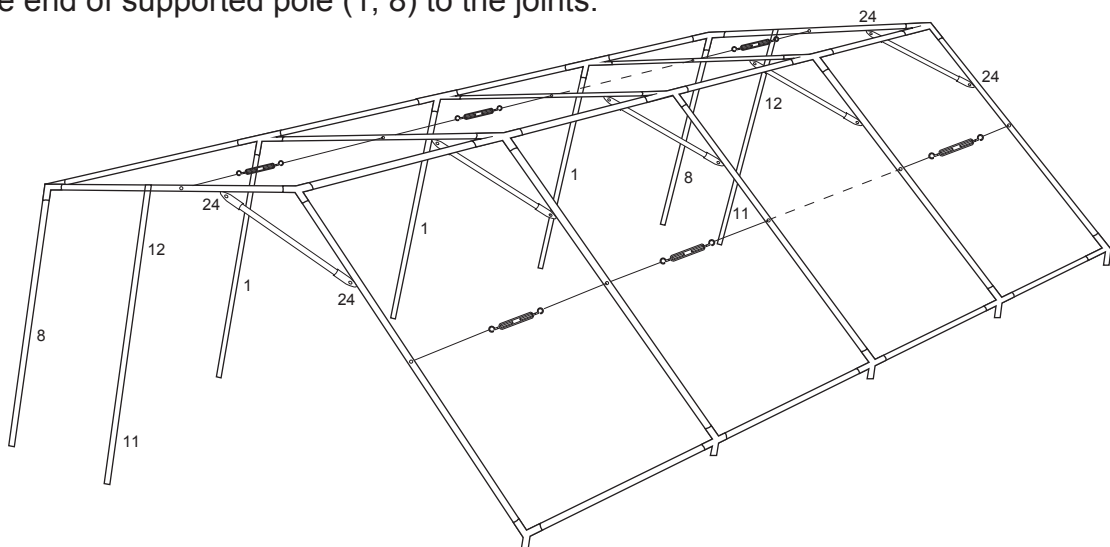

IV

Attach the other supported poles (1, 8) to the joints, built-up the framework.

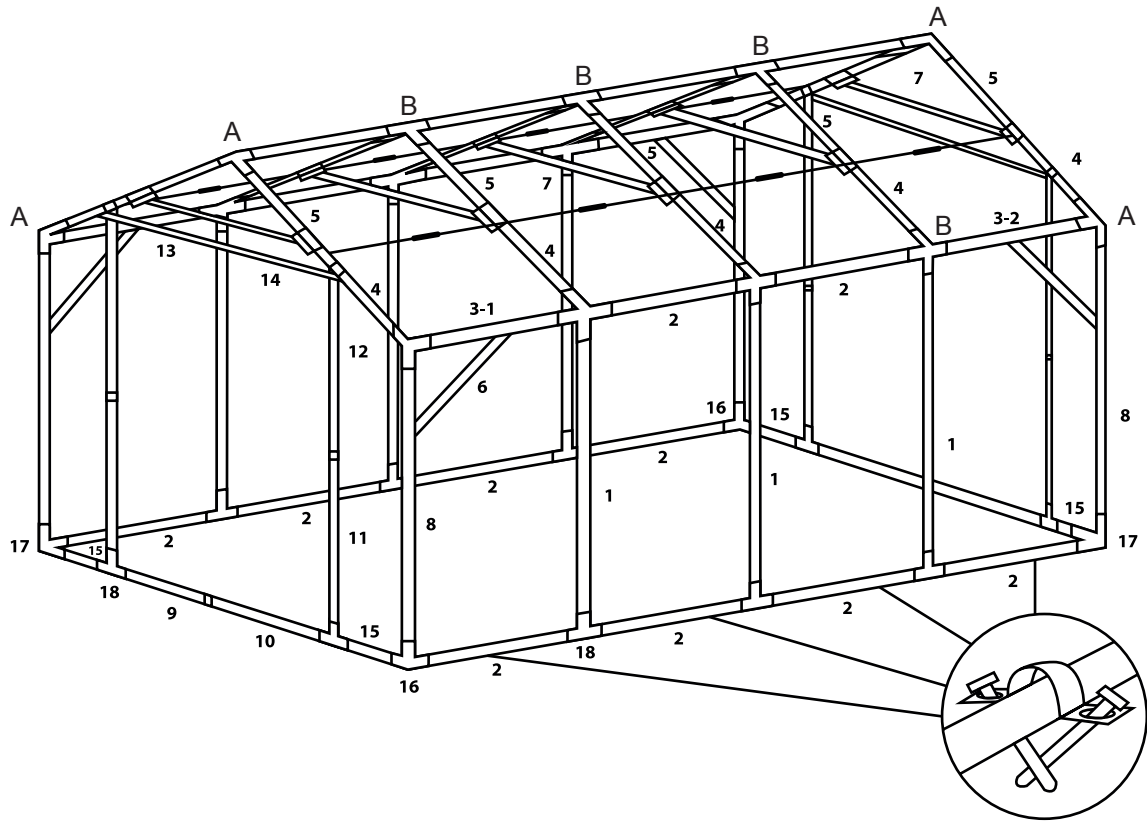

V

You facilitate the assembly and dismantling by pulling the roof with ropes on tent frame. Use the steel clips to fasten the cover to the frame. Each section we offer bracket and nail to fasten the frame to ground.

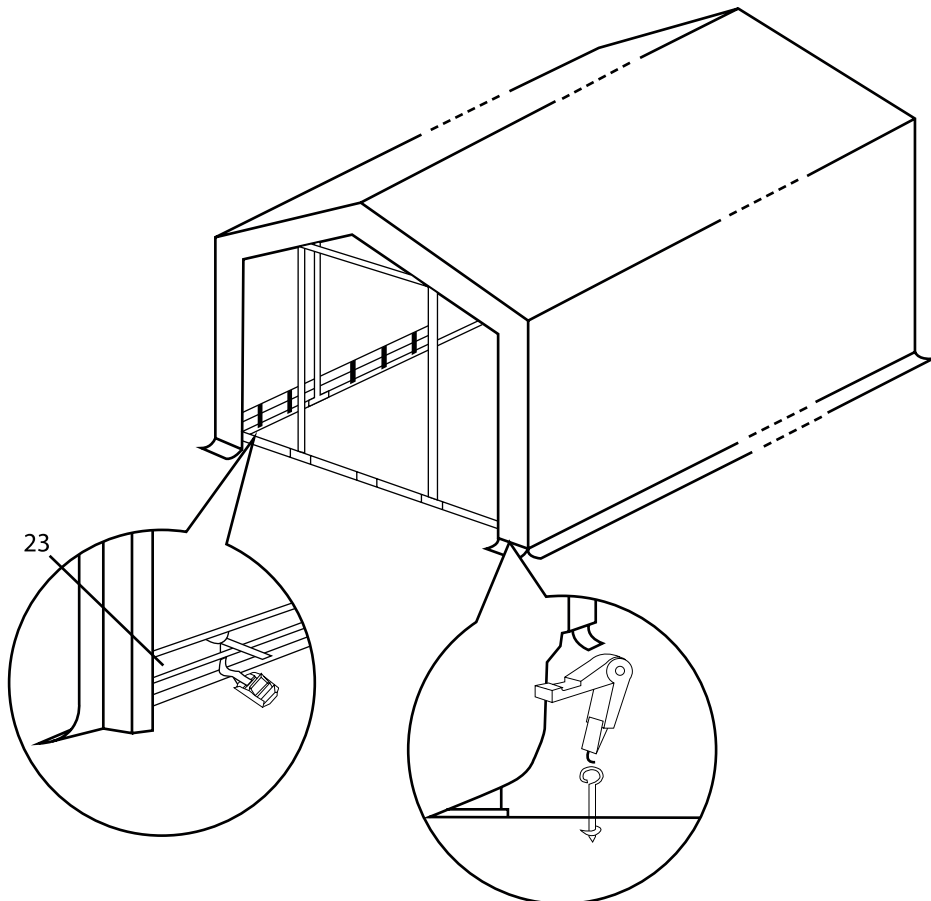

VI

Spread the wall panel and door panel, attach to framework by using the bungee cords clasping the frame to grommets that is construct over the wall panel and door panel to ensure stability. Also use the short pegs to fix the doors to the ground.

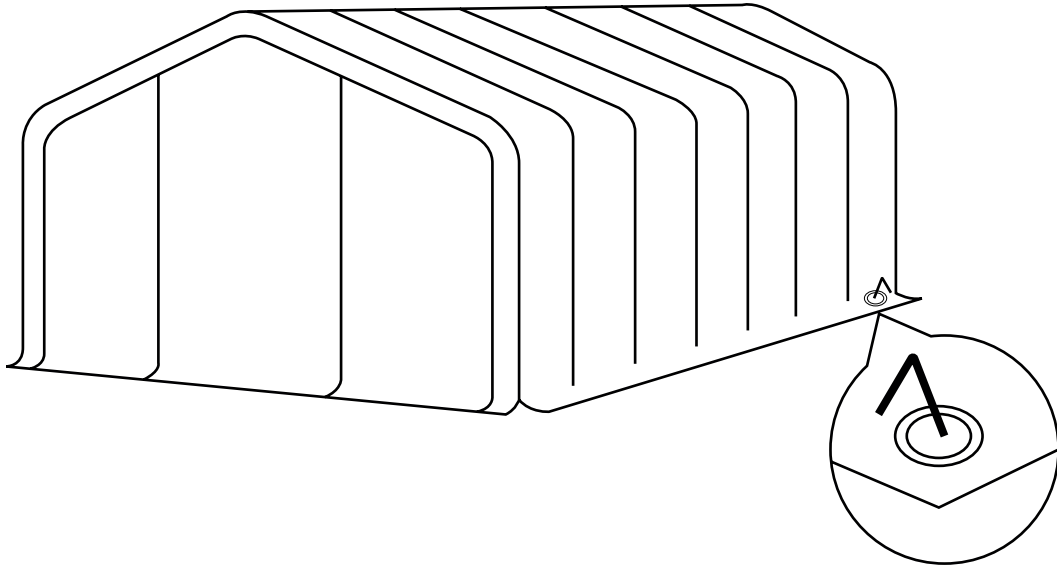

DANCOVER[®]

.com

Contact information

Head office:

Dancover A/S
Nordre Strandvej 119 G
3150 Hellebæk
Denmark

For more information
please visit:
www.dancovershop.com

National contact

Denmark: 70 26 76 20
denmark@dancover.com

UK: 020 8099 7570
uk@dancover.com

Germany: 041 0266 7040
germany@dancover.com

France: 0975 181 800
france@dancover.com

Sweden: 040 233 262
sverige@dancover.com

Finland: 0 931 581 720
suomi@dancover.com

Poland: 22 300 8602
polska@dancover.com

Luxembourg: +49 041 0266 7040
luxembourg@dancover.com

Portugal: 308 800 899
portugal@dancover.com

Spain: 911 436 828
espana@dancover.com

Italy: 02 479 21 198
italia@dancover.com

Switzerland: 0840 000125
schweiz@dancover.com

Austria: 0662 626935
austria@dancover.com

Norway: 231 00 690
norge@dancover.com

Nederland: 0 858 880 524
nederland@dancover.com

Ireland: 0 151 33 003
ireland@dancover.com

Belgium: 0 28 08 08 09
belgique@dancover.com