

DANCOVER[®]

.com

Manual
for
Storage Tent
7m Series PVC/PE

DANCOVER[®]

.com

Safety Advice

Attention

In some countries approval is needed to set up a tent larger than 75 m². It is your responsibility to comply with local rules and regulations and to ensure that the tent is assembled correctly.

In case of bad weather conditions, it is your responsibility to ensure the tent is safely secured and that the tent does not cause damage to others.

Do not use open fire, welding equipment or other sources which can ignite, inside or close to the tent.

The tent must be safely secured. We recommend you secure your tent with straps and pegs as soon as it is assembled.

Make sure to check if the tent is covered by your home contents insurance.

Tents must be evacuated under extreme weather conditions.

In the event of snow, always remove snow from the roof of the tent regularly to prevent snow from building on the roof, as heavy snow can cause the tent to collapse.

In the event of rain, there is a risk of rain puddles building up on top of the roof of the tent. Heavy rain puddles can cause the roof to collapse. It is your responsibility to ensure rain puddles do not build up. As a precaution, make sure the roof of the tent is stretched out properly and adequately over the side frames of the tent and remove rain water regularly.

Do not unpack or repack your tent in freezing temperatures. In case of temperatures below zero, always unpack and repack your tent indoors to avoid the risk of cracking parts.

The tent must be totally dry before you repack and store it to avoid mildew.















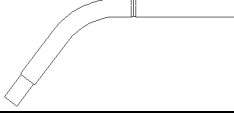
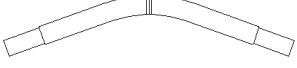

Note: Dancover warranty applies only to the normal use of the Product, normal wear and tear excepted, in accordance with written use instructions or manual. The warranty does not apply to damage caused by accident, abuse, misuse, or modification of the Product.







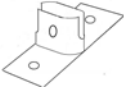
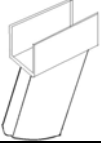









Warranty Information

Please visit dancovershop.com for information on warranty.

Please always check our website for the latest safety advice and manual.

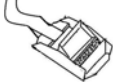
Instruction

			7x7	7x14
1	Back leg		4	4
2	Back leg		8	18
3	Crossbar		8	16
4	Ceiling rail		6	11
5	Ceiling rail		6	11
6	Extension pipe		4	4
7	Corner arch		12	22
8	Center arch		6	11
9	Connecting pipe		44	99
10	Connecting pipe		11	11
11	Extension pipe		8	18
12	Extension pipe		12	22
13	Door pillar		4	4
14	Door pillar		4	4
15	Cross bar		8	8
16	Foot base		16	26
17	Connecting component		4	4
18	Fasten bar		10	20

19	Nail 10x305mm		8	16
20	Nail 6x180mm		34	60
21	Nail 8x300mm		32	54
22	Spiral nail 10x700mm		4	4
23	1.75" Screw		8	12
24	2.5" Screw		14	24
25	4" Screw		68	124
26	Wing nut		90	160
27	Floor Bracket (set of 2 pcs)		4	8
28	Bungee ball		80	80
29	Spanner		2	2
30	Bolt with nut		30	40
31	Tie-down kit		4	4
32	Steel clip		20	40
33	Steel wire		8	12
34	Rope		4	4
35	Rope		2	2

7m storage pro	Part 23		Part 24		Part 25		Part 26		Part 30	
	M6x45 Screw		M6x65 Screw		M6x105 Screw		M6 Wing nut		M8x55 Bolt with nut	
	7x7m	7x14m	7x7m	7x14m	7x7m	7x14m	7x7m	7x14m	7x7m	7x14m
Used for Part 4 and Part 5	6	11					6	11		
Used for Part 4 and Part 6			2	2			2	2		
Used for Part 5 and Part 6			2	2			2	2		
Used for Part 4 and Part 11			4	9			4	9		
Used for Part 5 and Part 11			4	9			4	9		
Used for Part 1 and Part 15			4	4			4	4		
Used for Part 13 and Part 15			4	4			4	4		
Used for Part 1 and Part 10					4	4	4	4		
Used for Part 6 and Part 10					2	2	2	2		
Used for Part 7 and Part 10					2	2	2	2		
Used for Part 8 and Part 10					1	1	1	1		
Used for Part 12 and Part 10					2	2	2	2		
Used for Part 1 and Part 9					4	4	4	4		
Used for Part 2 and Part 9					16	36	16	36		
Used for Part 6 and Part 9					2	2	2	2		
Used for Part 7 and Part 9					10	20	10	20		
Used for Part 8 and Part 9					5	10	5	10		
Used for Part 11 and Part 9					8	18	8	18		
Used for Part 12 and Part 9					10	20	10	20		
Used for Part 1 and Part 16									4	4
Used for Part 2 and Part 16									8	18
Used for Part 14 and Part 15									4	4
Used for Part 17 and Part 13									4	4
Used for endwall										
	6	11	20	30	66	121	92	162	20	30

Attention

Please use gloves when assembling the metal frame of this unit. The metal components of this product have been treated, with a rust preventive coating. This coating is not dangerous, but you may grease your hands during assembly. We recommend that you wipe metal parts clean with a mixture of warm water and dish detergent prior to assembly. Should your hands become dirty, simply wash with soap and water.

After the frame is set up, it should look like the pictures shown below.

7x7

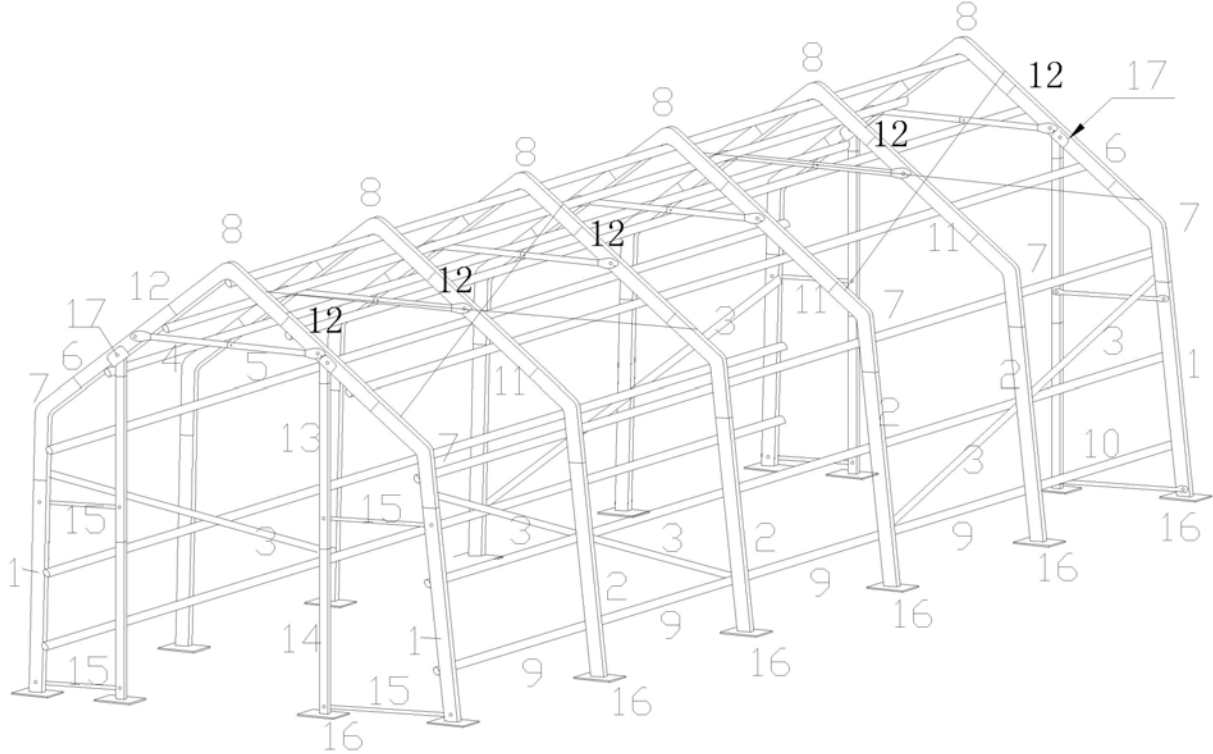

7x14

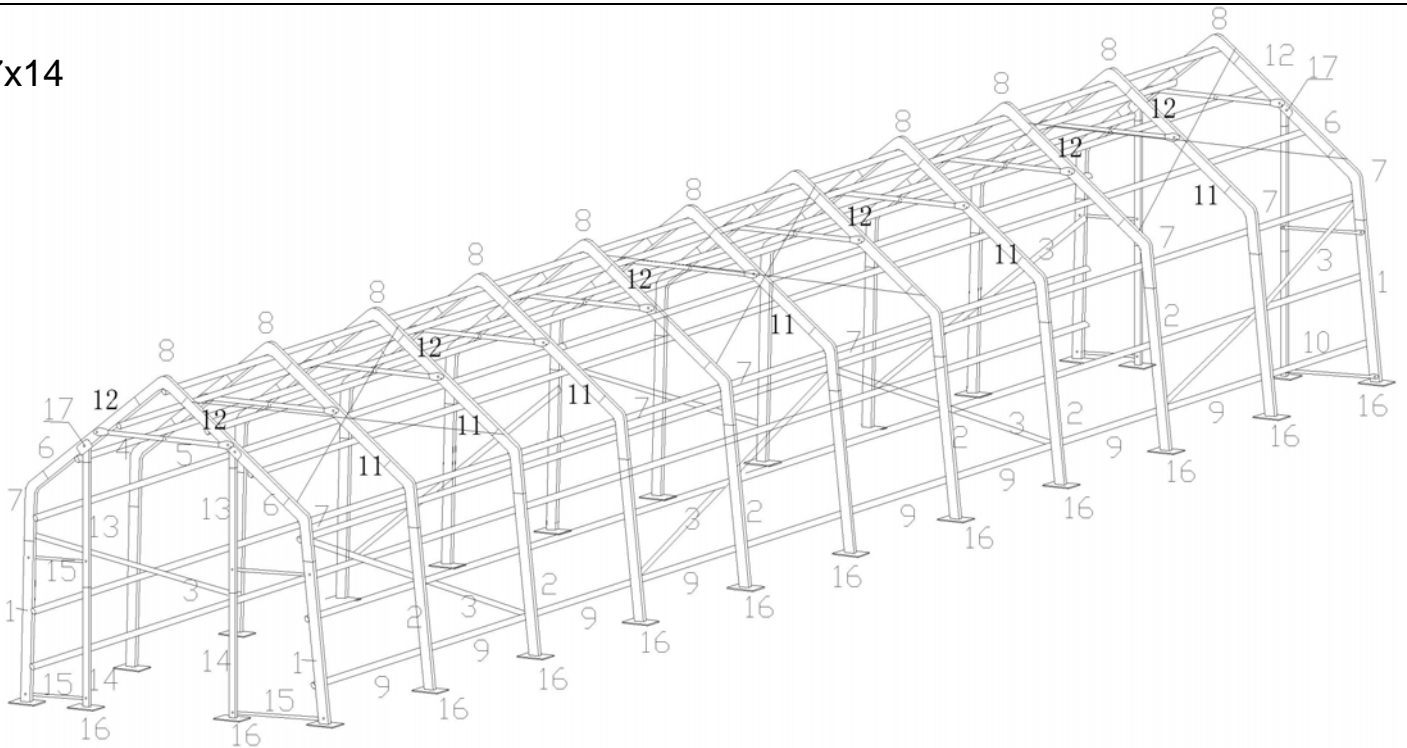

Please assemble the frame in these steps. All sizes have similar assemble step. Here we take 7x7 as an example.

Step 1,
When assembling the tent, make sure that all the wing nuts are attached to the inside.
Connect one center arch pipe(8) with the extension pipe(12). Attach the corner arch(7) to the ends of the extension pipe(6.) Now connect the ceiling rail(4 and 5) with each other using the 1.75" screw and the wing nuts. Connect extension pipe (6) and (12) together then attach ceiling rail to extension pipe(6 and 12) using the 2.5" screws and wing nuts.

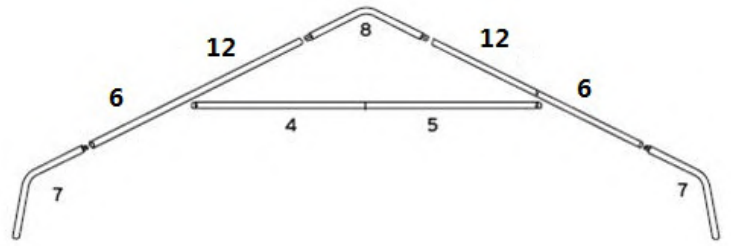

Step 2,
Repeat step 1 for the next 5/10 elements to place them on the ground one after another, as illustrated.

Attention: all elements with extension pipe no.6 need to be placed at the ends. Extension pipe no.6 has holes for door pillar.

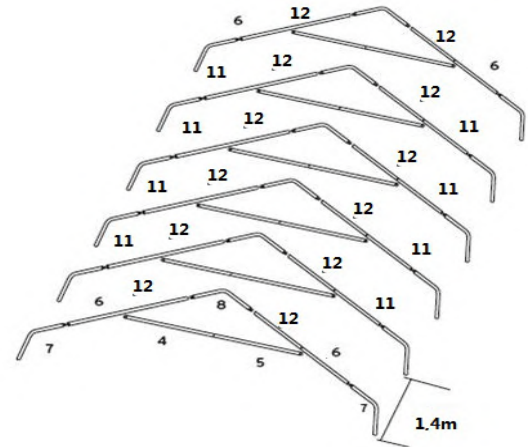

Step 3,
Now connect the 6 arch elements with each other using the connecting pipes (9 and 10). Note that only corner arch 10 are used for the front segments. Use the 4" screw and wing nut to tighten them.

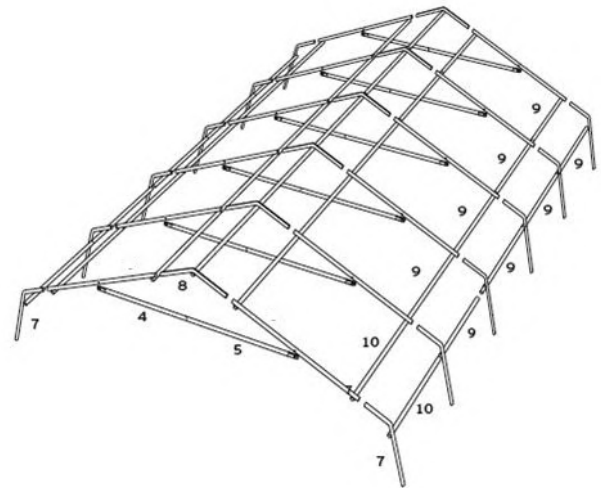

Step 4,
Strengthen the frame with steel wire.

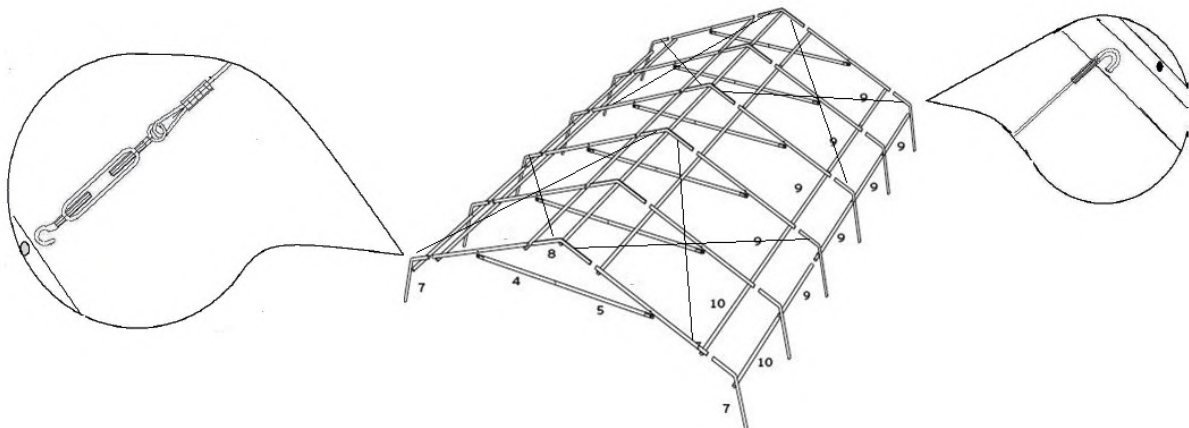

Step 5,

Start setting up one side first. Connect the corner arch(7) with the legs (1 and 2). Secure the frame using the connecting pipes (9 and 10). Attach the diagonal pipes (3) to the back legs (1). Please refer to the completed frame pictures to attach the diagonal pipes.

Screw tighten the tent at the feet, using the 4" screws and wing nuts

Use the floor bracket and the 10x305mm pegs to fasten the frame to the ground.

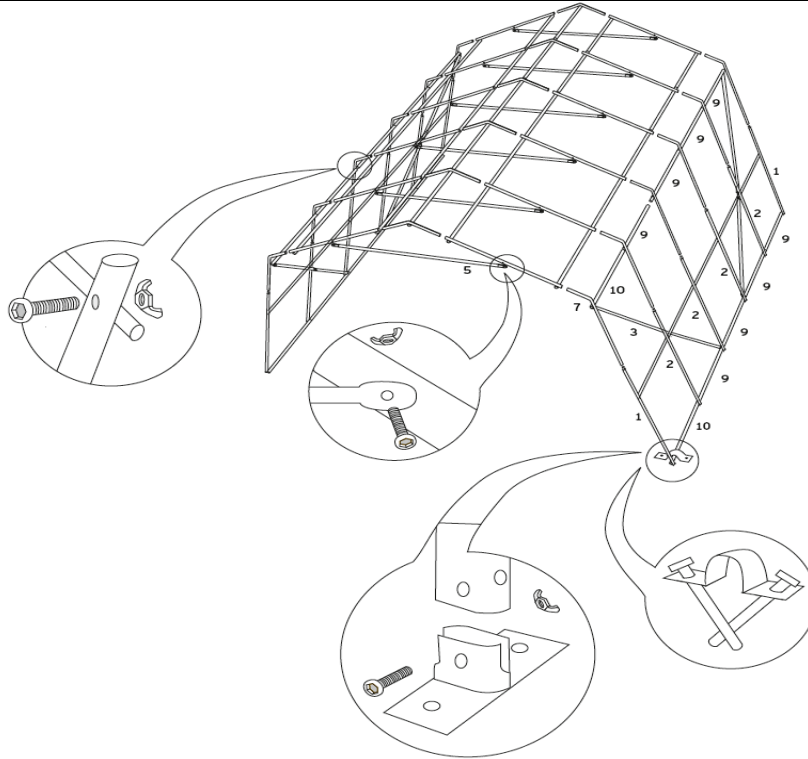

Step 6,

Unfold the tent cover and put it over the frame. Insert the fasten bar(18) into the loop at the lower end of roof and fasten it with steel clips. Attach the end wall to the frame using the bungees. Tension the roof cover to the tent frame to the ground using the 8x700mm pegs.

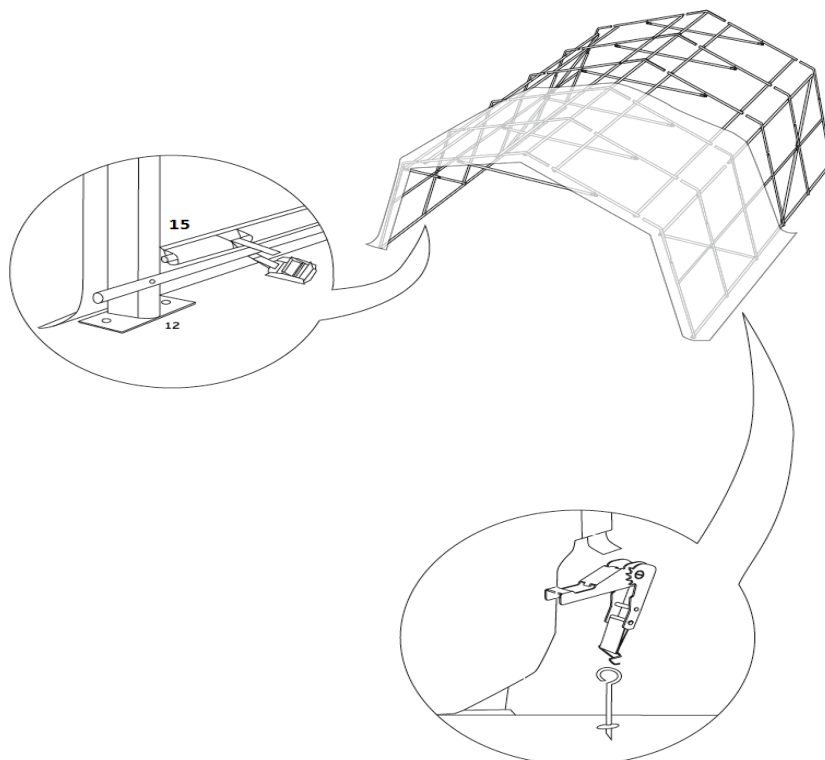

Step 7,
Assemble the pillar set like on the picture below.

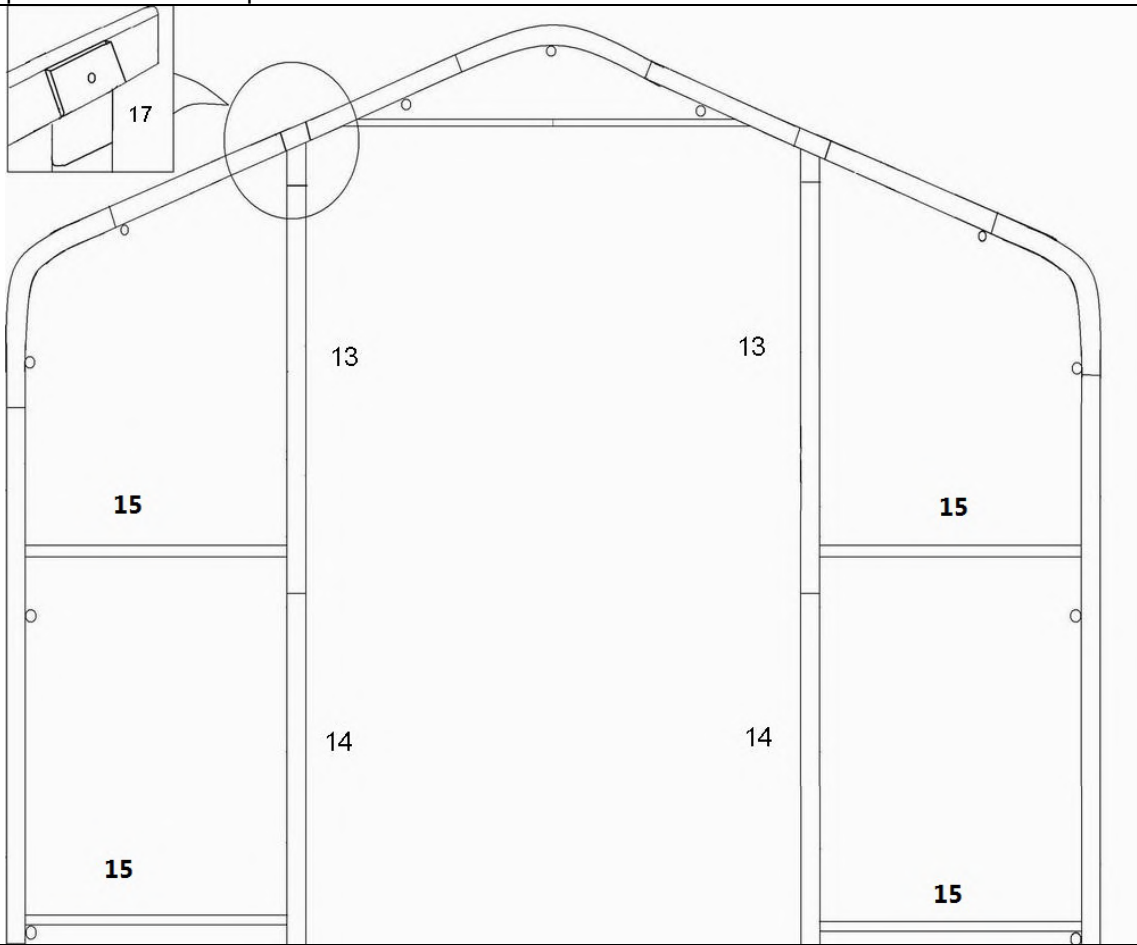

Step 8,
Use the ropes to attach the door and cover to the frame. Find a proper way and strength to attach the cover to the frame carefully. Please do not use too much strength to tear the eyelet out of fabric.

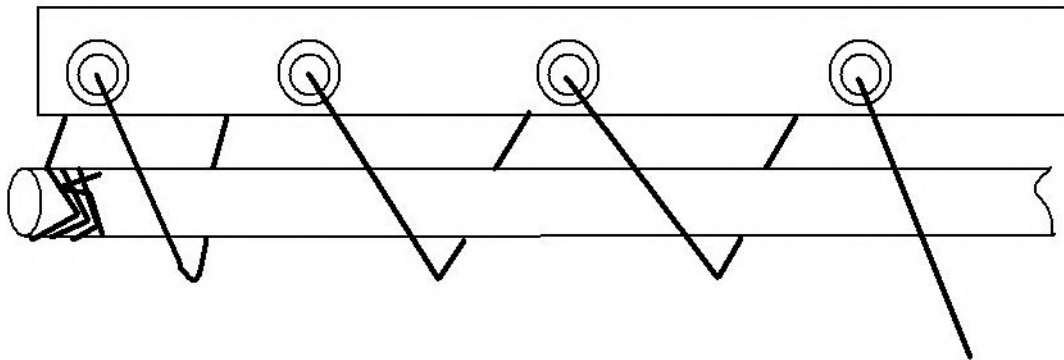

Contact information

Head office:

Dancover A/S
Lyngevej 16A, Nørre Herlev
3400 Hillerød
Denmark

For more information
please visit:

www.dancovershop.com

National contact

Denmark:

denmark@dancover.com

UK:

uk@dancover.com

Germany:

germany@dancover.com

France:

france@dancover.com

Sweden:

sverige@dancover.com

Finland:

suomi@dancover.com

Poland:

polska@dancover.com

Luxembourg:

luxembourg@dancover.com

Portugal:

portugal@dancover.com

Spain:

espana@dancover.com

Italy:

italia@dancover.com

Switzerland:

schweiz@dancover.com

Austria:

austria@dancover.com

Norway:

norge@dancover.com

Nederland:

nederland@dancover.com

Ireland:

ireland@dancover.com

Belgium:

belgique@dancover.com