

# MODULARO™

WOOD SHED RIGA  
4,25x2,8x2,22m

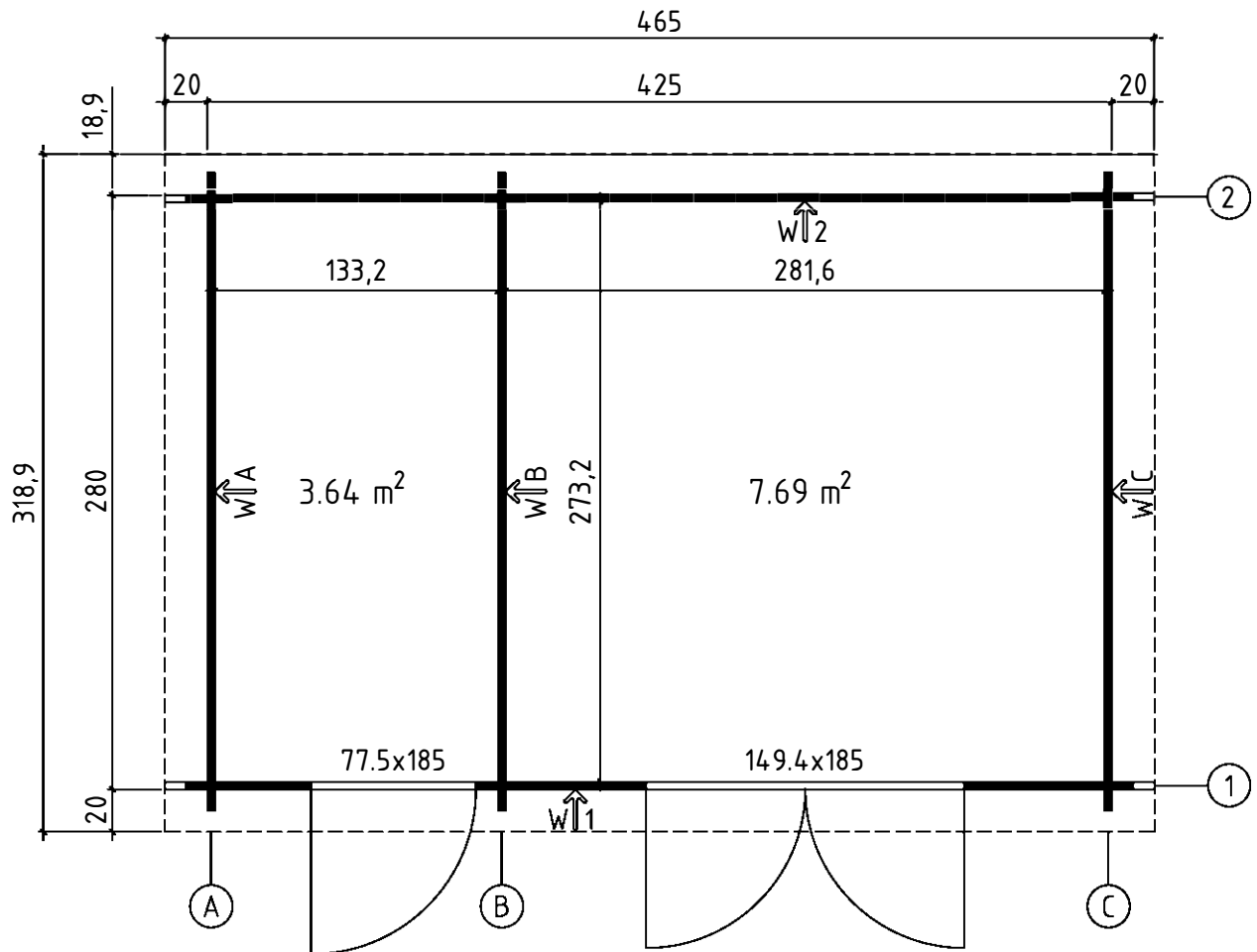

Groundplan - Grundplan - Plan de masse - Planimetria - Plattegrond - Põhiplaan



Foundation - Fundament - Fondation - Fondamenta - Fundering - Immutatud alusraam

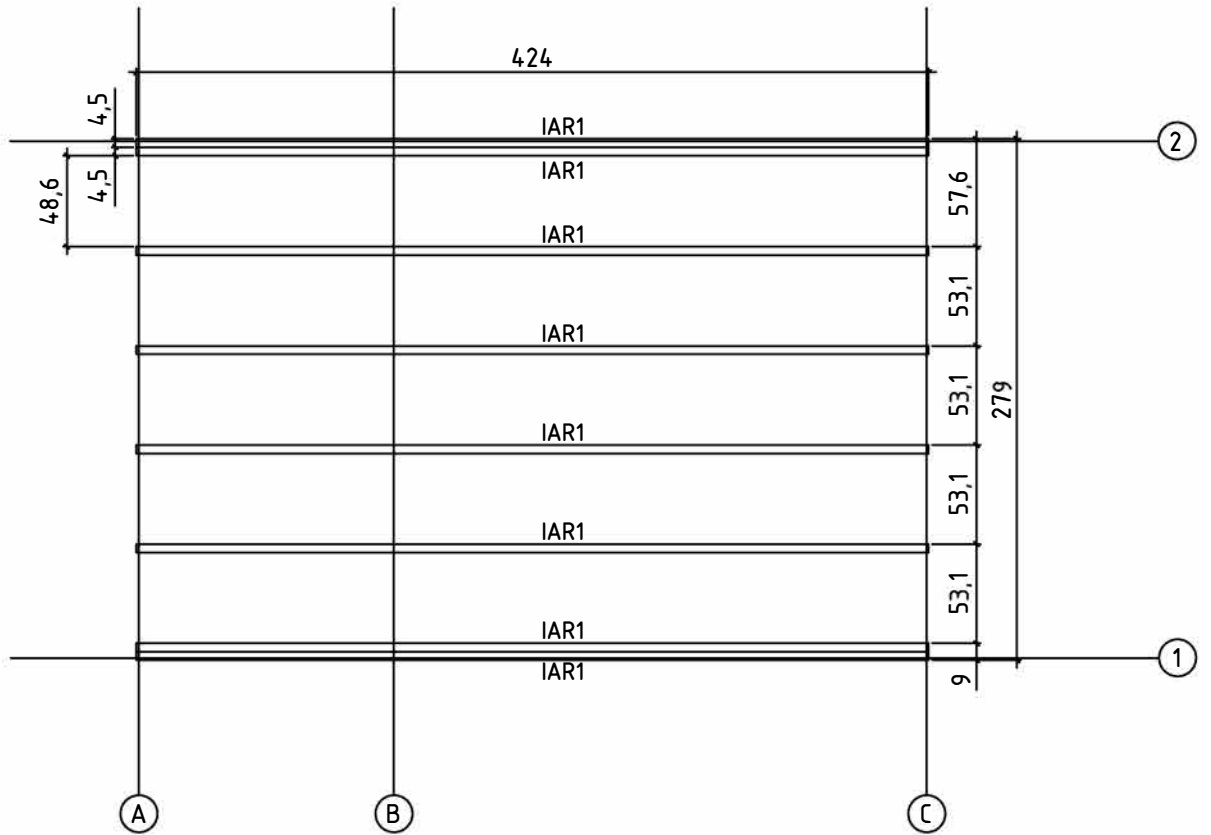

Floor boards - Fussbodenbretter - Plan pose plancher - Pavimento - Vloerhout - Põrandalaudis

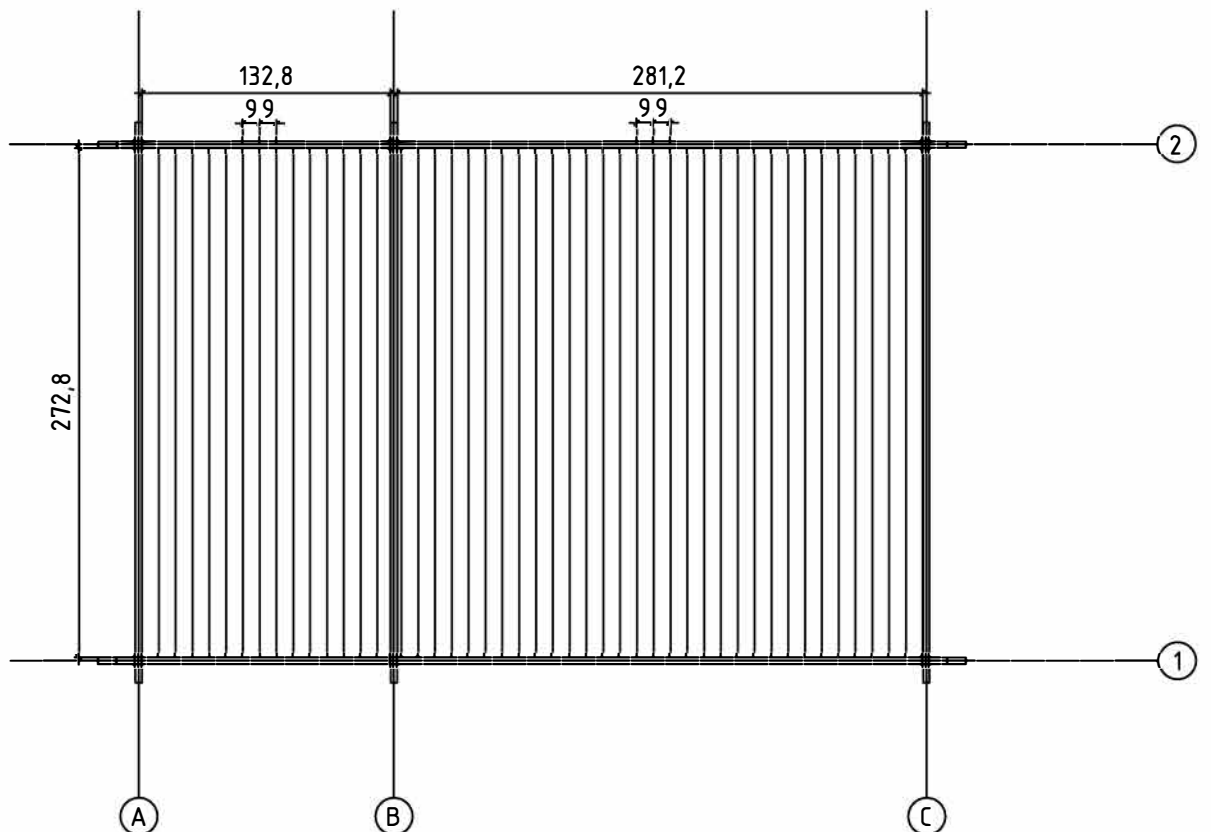

Art.Nr. WC165370

465

Without tongue - Ohne feder - Madrier de finition -  
Finale in legno - Zonder veer - Punnita

20  
19  
18  
17  
16  
15  
14  
13  
12  
11  
10  
9  
8  
7  
6  
5  
4  
3  
2  
1  
W-1

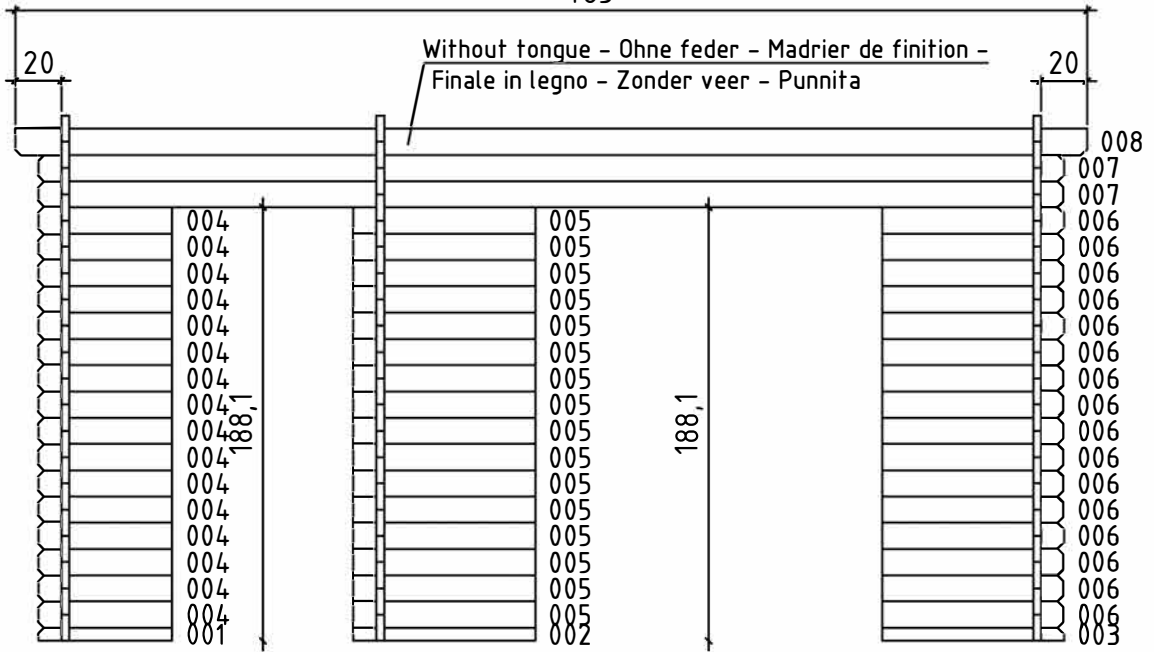

222,3

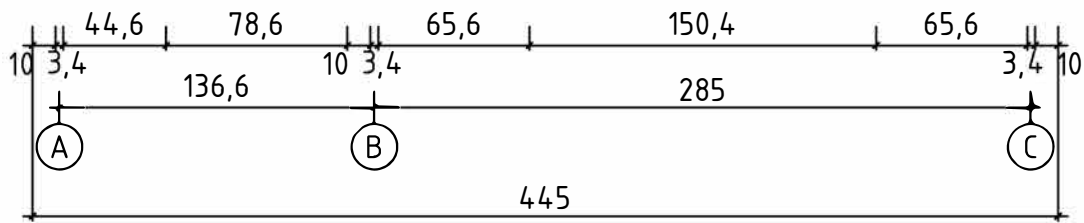

465

Without tongue - Ohne feder - Madrier de finition -  
Finale in legno - Zonder veer - Punnita

18  
17  
16  
15  
14  
13  
12  
11  
10  
9  
8  
7  
6  
5  
4  
3  
2  
1  
W-2

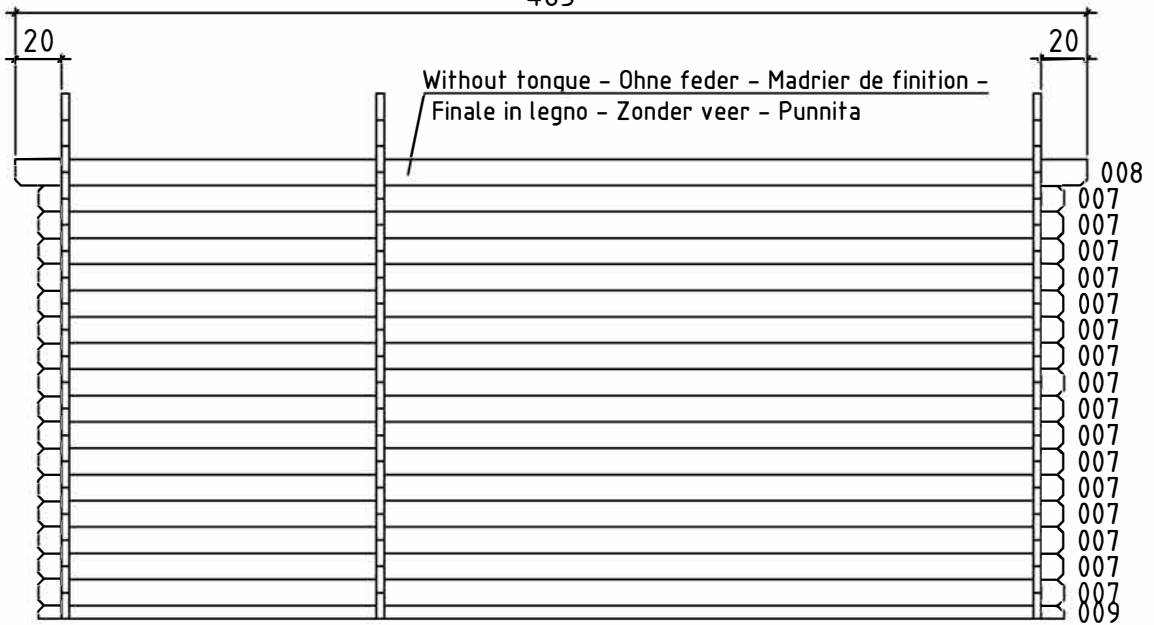



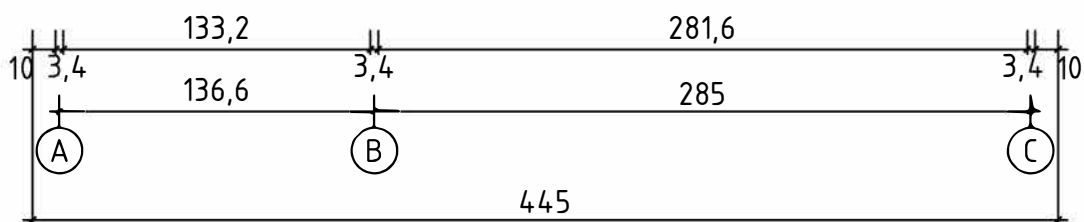



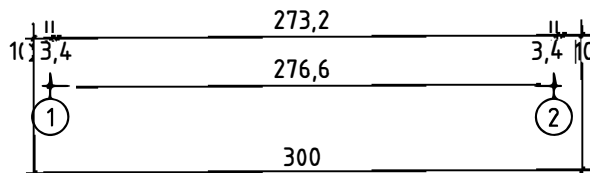
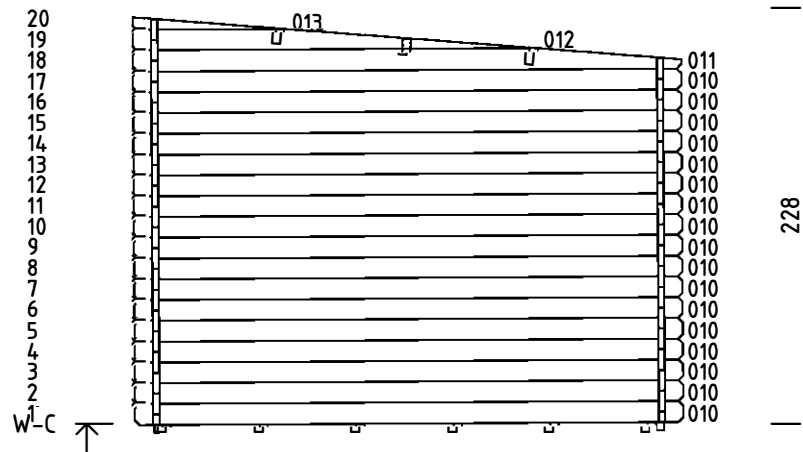
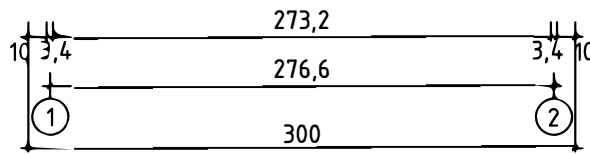
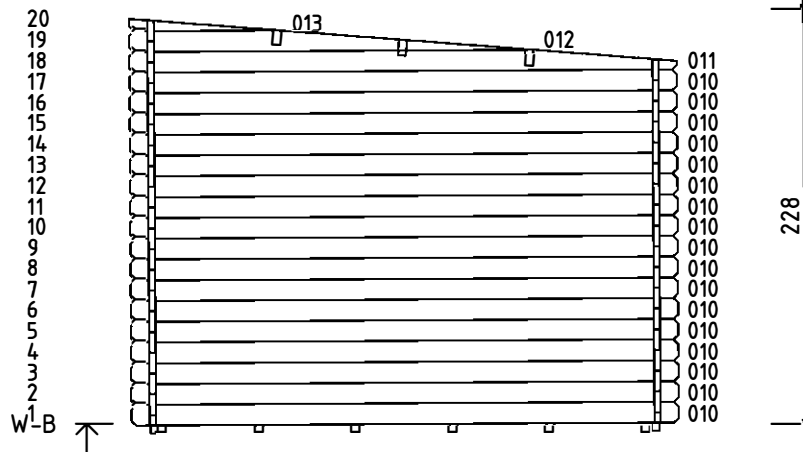
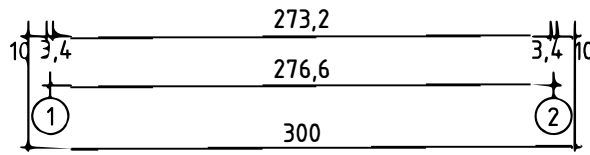
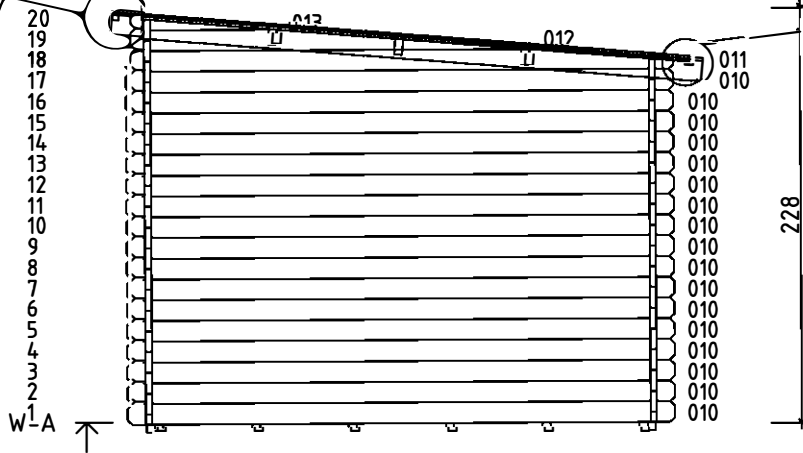
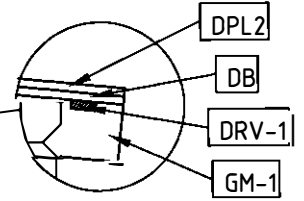
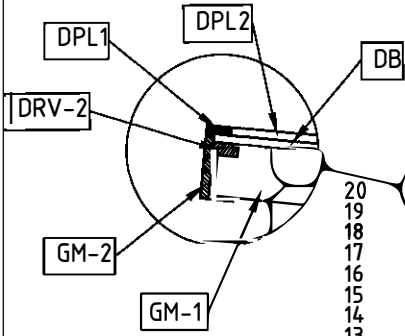

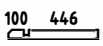
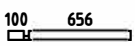
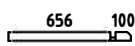
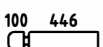
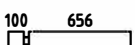



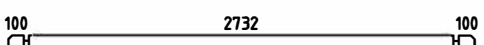
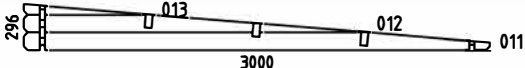
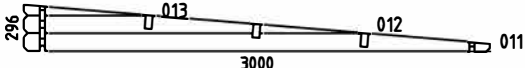
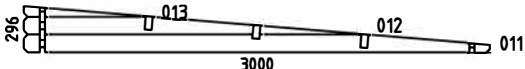

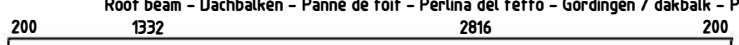
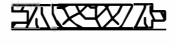









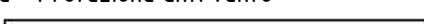

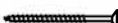



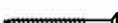

199,5



Art.Nr. WC165370



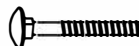

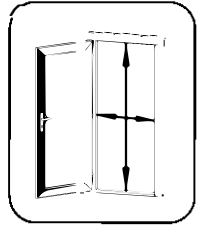
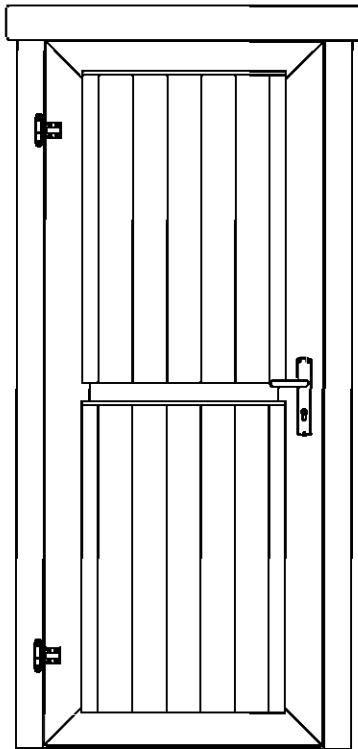

Pos	13.10.2017 Piece list - Stückliste - Liste des pièces - Elementi - Stuklijst - Tükitalabel Art.Nr. WC165370 6/7	Q	P (mm)	L (mm)
001		1	34x57	580
002		1	34x57	790
003		1	34x57	790
004		16	34x114	580
005		16	34x114	790
006		16	34x114	790
007		18	34x114	4450
008		2	34x114	4650
009		1	34x57	4450
010		51	34x114	3000
WA-1		1		
WB-1		1		
WC-1		1		
IAR1	Foundation - Fundament - Fondation - Fondamenta - Fundering - Immutatud alusraam 	8	45x45	4240
A-PR1	Roof beam - Dachbalken - Panne de toit - Perlina del tetto - Gordingen / dakbalk - Pärilin 	3	44x140	4650
	Floor boards - Fussbodenbretter - Lame de plancher - Pavimento - Vloerhout - Põrandalaud 	47	90x15	2728
DB	Roof boards - Dachbretter - Voliges - Perlina per tetto - Dakhout - Katuselaud 	52	90x15	3200
	Floor fillet - Fussbodenleiste - Corniere de finition du plancher - Finitura per pavimento (battisco pa) - Vloerafwerkljst - Põrandaliist 		18x18	19.19
DPL1	Roofing felt fillet - Dachpappenleiste - Baguette de fixation du feutre bitumeux - Asse per fissaggio guaina bituminosa - Afdeklijst asfaltpapier - Katusepapiiist 	2	15x45	2340
DPL2	Roofing felt fillet - Dachpappenleiste - Baguette de fixation du feutre bitumeux - Asse per fissaggio guaina bituminosa - Afdeklijst asfaltpapier - Katusepapiiist 	2	15x45	3250
DPP-1	Roofing felt (strip) - Dachpappe (bahnen) - Feutre bitumeux (bande) - Cartone catramato - Asfaltpapier (baan) - Katusepapp 	4		4750
DRV-1	Roof edge reinforcement - Dachrandverstärkung - Corniere de renfort de bord de toit - Rinforzo x tetto - Dakrand versterking - Räästatugevdus 	2	15x45	2325
DRV-2	Roof edge reinforcement - Dachrandverstärkung - Corniere de renfort de bord de toit - Rinforzo x tetto - Dakrand versterking - Räästatugevdus 	2	28x34	2325

Pos	13.10.2017 Piece list - Stückliste - Liste des pièces - Elementi - Stuklijst - Tükitalabel Art.Nr. WC165370 7/7	Q	P (mm)	L (mm)
KFS-1	Storm protection - Sturmleiste - Latte anti-tempete - Protezione anti vento - Stormverankering / beveiliging - Tormikinnitusliist 	2	22x45	2050
KFS-2	Storm protection - Sturmleiste - Latte anti-tempete - Protezione anti vento - Stormverankering / beveiliging - Tormikinnitusliist 	2	22x45	2500
GM-1	Gable moulding - Giebelleiste - Planche de rive - Finitura per frontale e retro del tetto - Gevellijst - Viilulaud 	2	15x120	3250
GM-2	Gable moulding - Giebelleiste - Planche de rive - Finitura per frontale e retro del tetto - Gevellijst - Viilulaud 	2	15x120	2325
HS9	Screw for gable moulding - Schrauben für giebelleiste - Vis pour fixation planche de rive - Vite per fissare finiture davanti e dietro del tetto - Schroef voor gevellijst - Kruvi viilulauale 	20	3.5x50	
HS4	Screw for roof edge reinforcement - Schrauben für dachrandverstärkung - Vis pour fixation corniere renfort de bord de toit - Viti x rinforzo bordo tetto - Schroef voor dakrand versterking - Kruvi räästatugevdusele 	10	3x30	
HS12	Screw for roof edge reinforcement - Schrauben für dachrandverstärkung - Vis pour fixation corniere renfort de bord de toit - Viti x rinforzo bordo tetto - Schroef voor dakrand versterking - Kruvi räästatugevdusele 	10	4x40	
HS12	Screw for gable moulding - Schrauben für giebelleiste - Vis pour fixation planche de rive - Vite per fissare finiture davanti e dietro del tetto - Schroef voor gevellijst - Kruvi viilulauale 	10	4x40	
HS18	Screw for roof beams - Schrauben für dachbalken - Vis pour fixation pannes de toit - Viti per perline del tetto - Schroef voor gordingen / dakbalken - Kruvi pärlinitele 	9	5x120	
HS18	Screw for gable - Schrauben für giebel - Vis pour fixation des pignons - Viti per timpano - Schroef voor gevelpunt - Kruvi viilude kinnitamiseks 	6	5x120	
HS16	Screw for 1. wall beam - Schraube für 1. bohlenreihe - Vis de fixations 1ere rangée de madriers avec poutrelles de fondations - Vite fissaggio alle fondamenta - Schroef voor 1 wandbalk - Kruvi poollauale 	6	5x90	
HS16	Screw for foundation - Schrauben zur befestigung fundament - Vis de fixations des poutrelles de fondations - Viti x fondamenta - Schroef voor fundering - Kruvi alusraamile 	6	5x90	
NF2	Zn nail for floor fillet - Zn nägel für fussbodenleiste - Pointe pour corniere de finition du plancher - Chiodi x fissaggio pavimento - Spijker(nagel) voor vloer afdeklijst - Nael põrandaliistule 	38	1.4x40	
SH34	Hammer block - Schlagholz - Calle de frappe - Blocco di legno da usare come cuscinetto quando si usa il martello - Slagklos - Löögiklots 	1		
SFS	Nut for storm protection - Schraubenmutter für sturmleiste - Ecrou pour latte anti-tempete - Dado x asta protezione vento - Moer voor stormverankering - Mutter tormikinnitusliistule 	8	D6	
NF4	Zn nail for roof - Zn nägel für dachbretter - Pointe pour fixation voliges de toit - Chiodi x perline tetto - Spijker(nagel) voor dakhout - Nael katuselauale 	277	2x50	
NF4	Zn nail for floor - Zn nägel für fussbodenbretter - Clous pour plancher - Chiodi x perline pavimento - Spijker(nagel) voor vloer - Nael põrandalauale 	294	2x50	
NF5	Zn nail for roofing felt fillet - Zn nägel für dachpappenleiste - Pointe pour baguette de fixation feutre bitumeux - Chiodi x carta bituminosa x tetto - Spijker(nagel) voor asfaltpapier afdeklijst - Papiliistunael 	28	2x40	
NF6	Roofing nails for roofing felt - Nägel für dachpappe - Pointe pour fixation feutre bitumeux - Chiodi per cartone catramato - Asfaltnagel - Papinael 	160	2.8x15	
BFS	Bolt for storm protection - Bolzen für sturmleiste - Boulon pour latte anti-tempete - Bullone x asta protezione vento - Bout voor stormankerlat - Puidupolt tormikinnitusliistule 	8	6x70	
DFS	Washer for storm protection - Dichtscheibe für sturmleiste - Rondelle pour latte anti-tempete - Rondella x asta protezione vento - Afdichtring voor storm strip - Seib tormikinnitusliistule 	8	D6	
	Door - Tür - Porte - Porte - Deur - Uks 1494x1850 TUK.1.108.XVP.MMX34c XGA+28	1		
	Door - Tür - Porte - Porte - Deur - Uks 775x1850 UL.2.050.IVV.MMX34 TA+28	1		

Pos	Piece list - Stückliste - Liste des pièces - Elementi - Stuklijst - Tükitabel 775x1850 UL.2.050.IVV.MMX34 TA+28	1/2	Q	P (mm)	L (mm)
-----	--	-----	---	-----------	-----------



702x1793 mm

1	Upper door jamb - Türrahmen oben - Cadre de porte supérieur - Telaio superiore della porta - Bovendorpel - Ukse ülemine leng		1	72x100	722
2	Left door jamb - Türrahmen links - Cadre de porte gauche - Telaio montante sinistro della porta - Linkerstijl deurframe - Ukse vasak leng		1	72x80	1850
3	Right door jamb - Türrahmen rechts - Cadre de porte droit - Telaio montante destro della porta - Rechterstijl deurframe - Ukse parem leng		1	72x80	1850
4	Doorstep - Swelle - Barre de seuil - Soglia della porta - Deurdorpel - Lävepakk		1	20x25	702





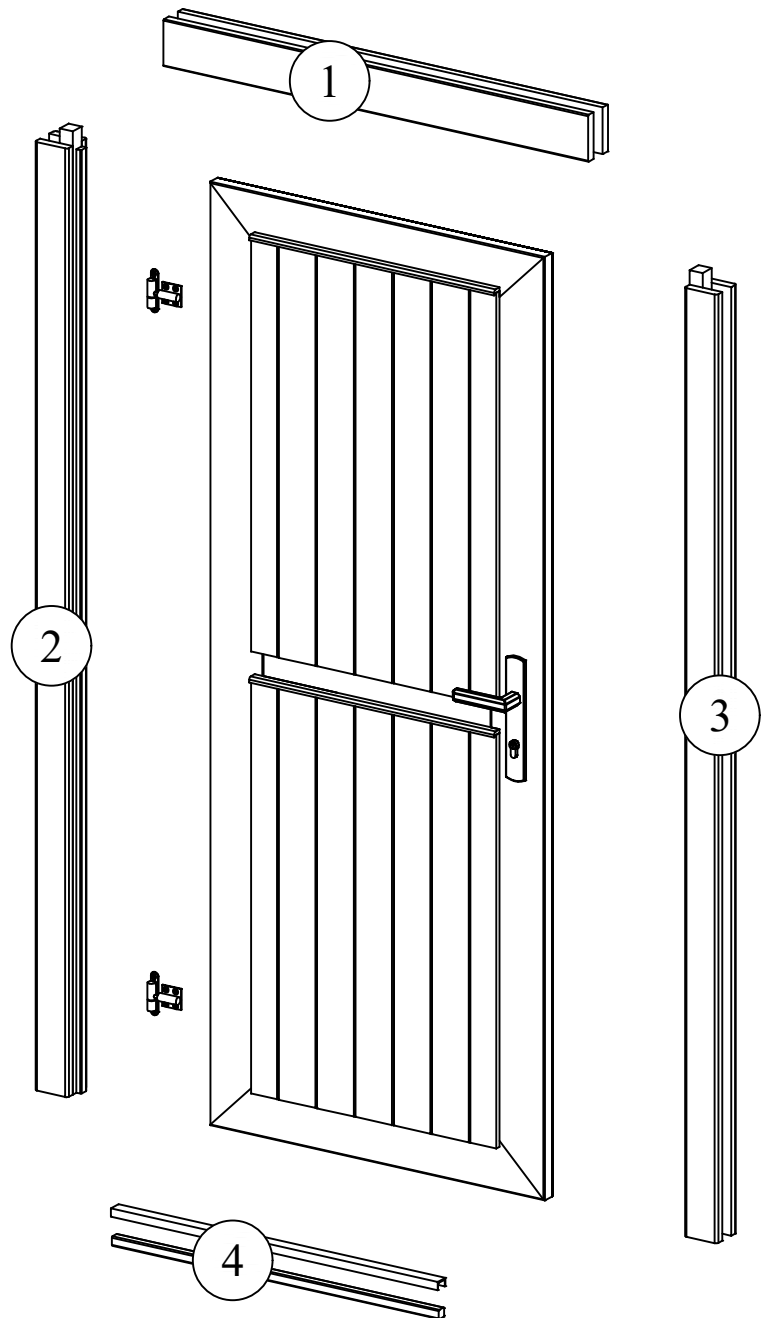

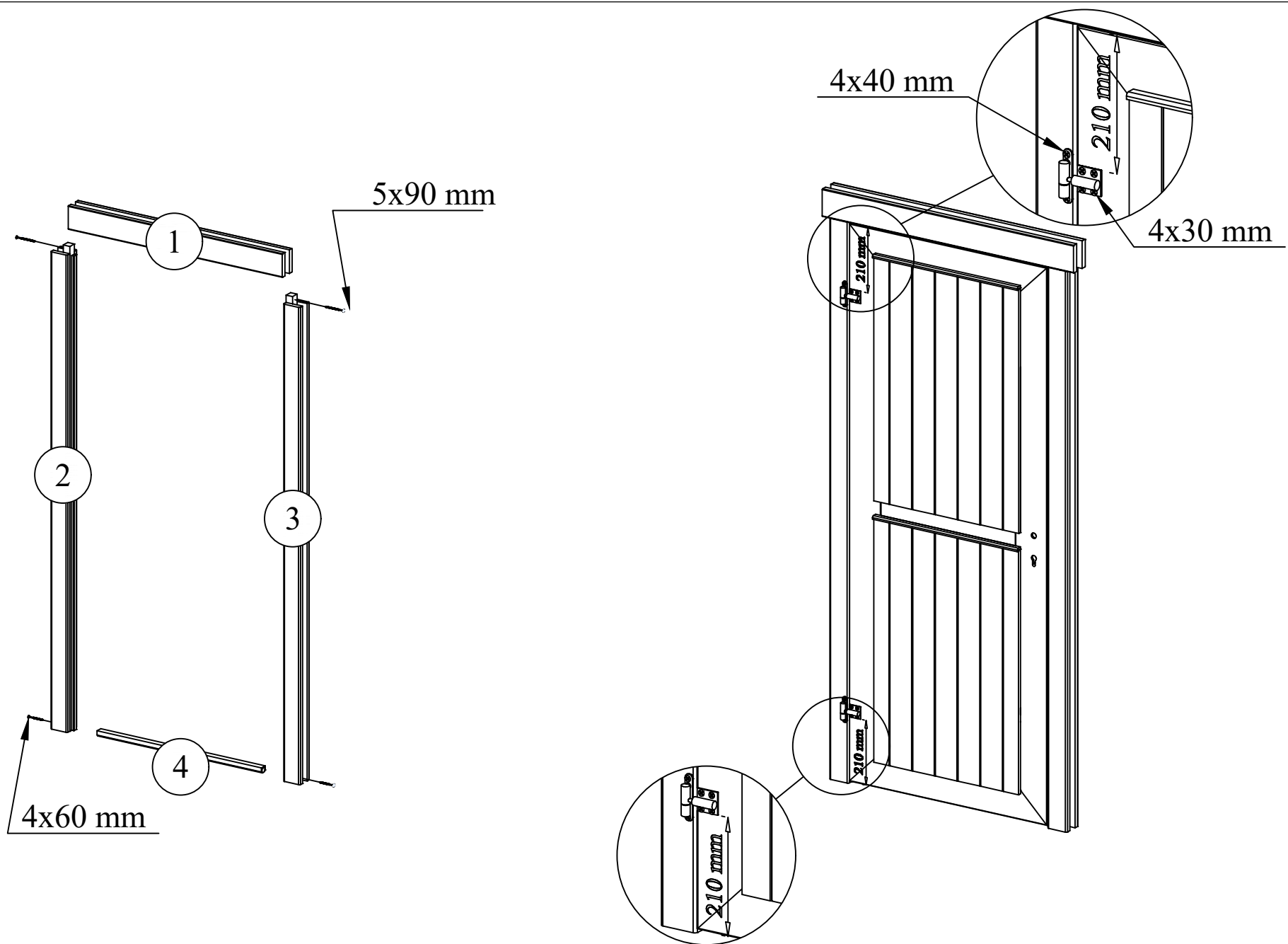

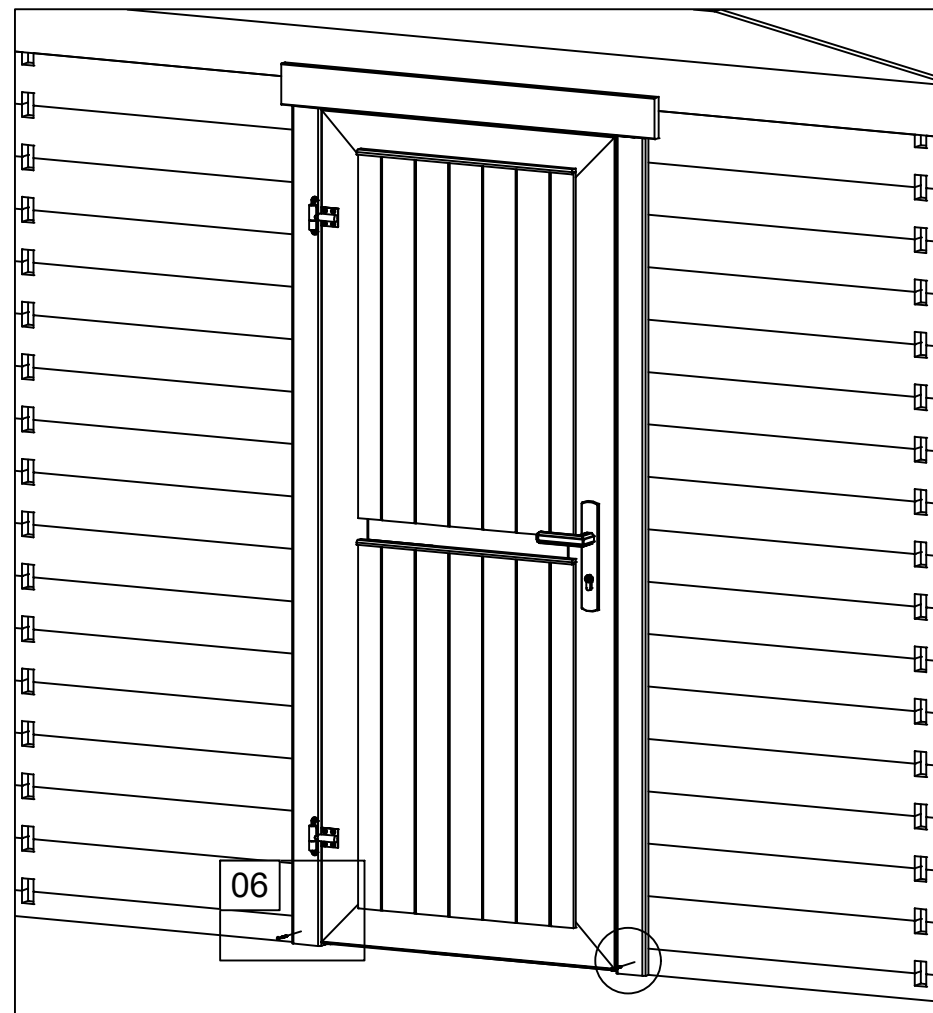
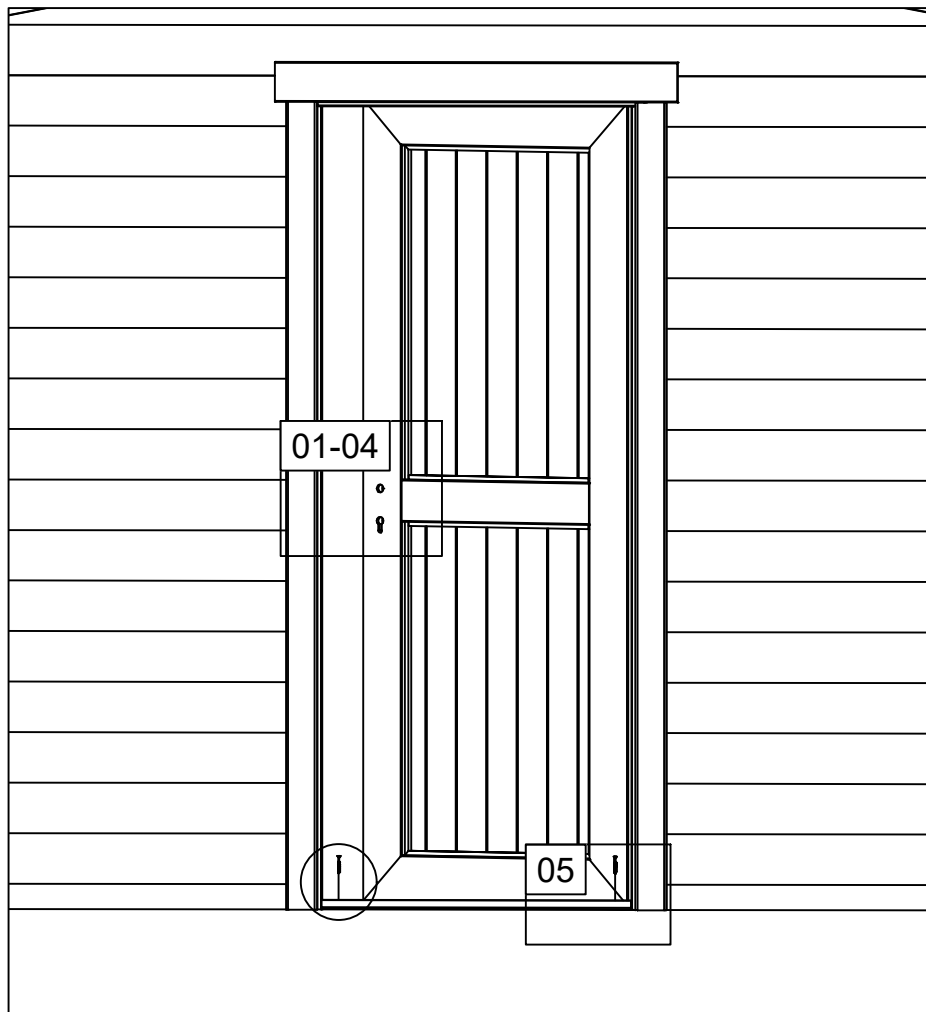

01

4x25 mm

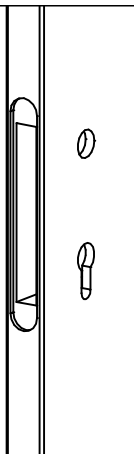
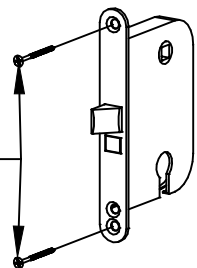

04

4x25 mm

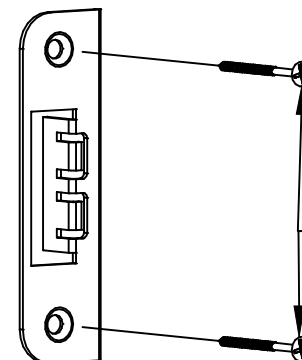

02

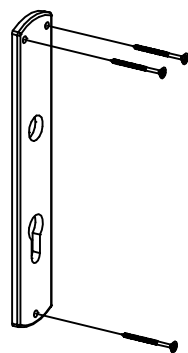
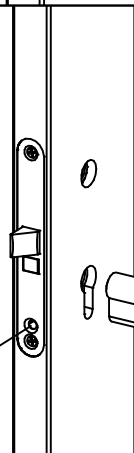
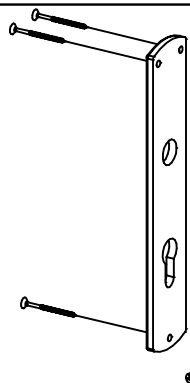

05

4.5x60 mm

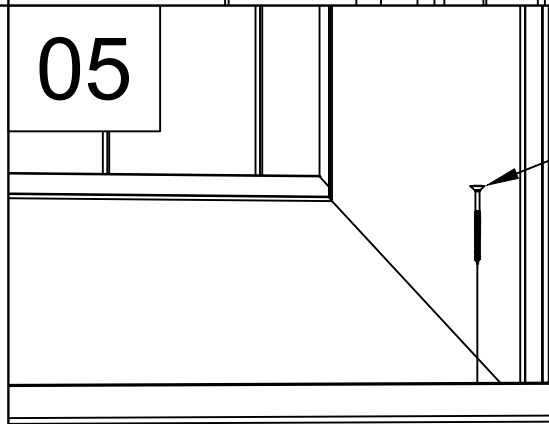



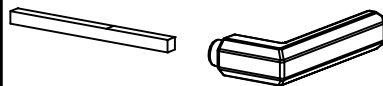
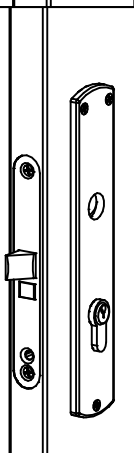
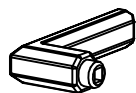



03

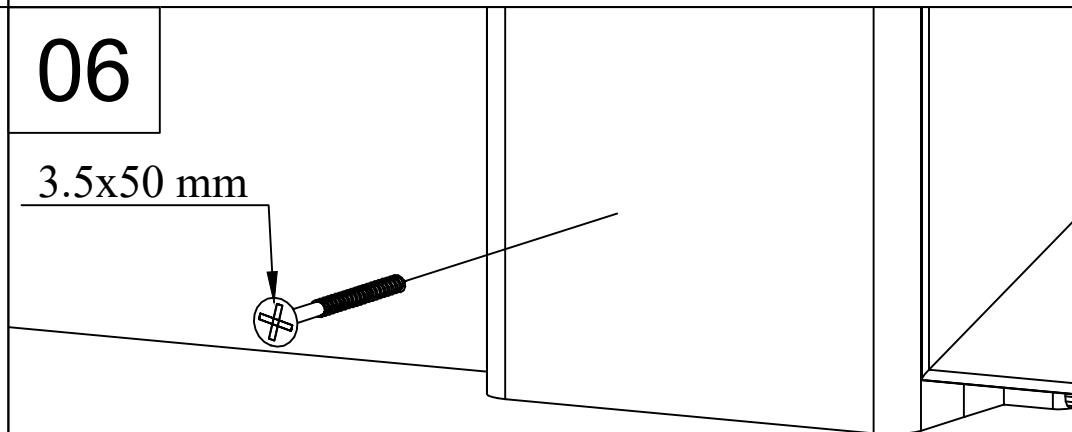

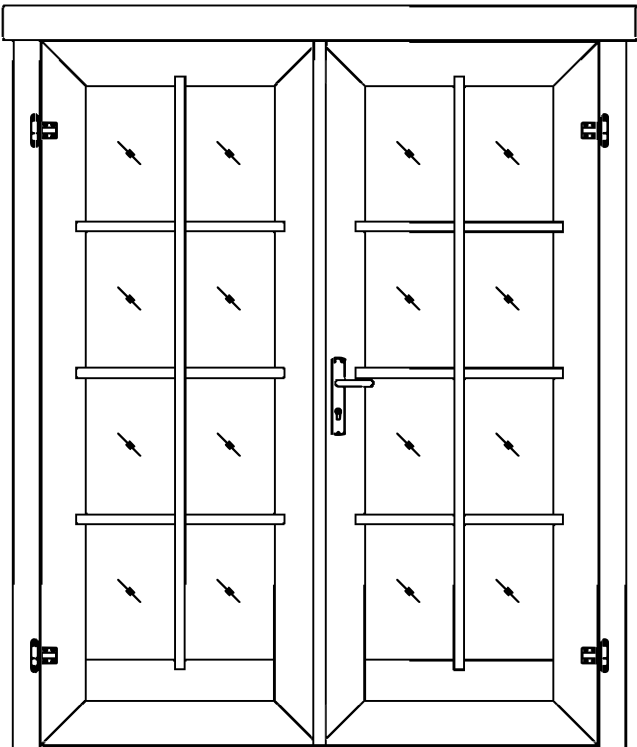
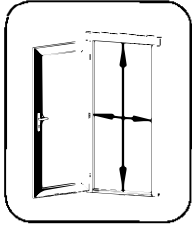
06

3.5x50 mm

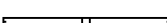

Pos	Piece list - Stückliste - Liste des pièces - Elementi - Stuklijst - Tükitalabel 1494x1850 TUK.1.108.XVP.MMX34c XGA+28	1/2	Q	P (mm)	L (mm)
	<p>Glass size - Glasgröße - Taille de la vitre - Misura del vetro - Glas afmeting - Klaasi mõõt: 502x1496 mm</p>   <p>1418x1794 mm</p>				
1	Upper door jamb - Türrahmen oben - Cadre de porte supérieur - Telaio superiore della porta - Bovendorpel - Ukse ülemine leng		1	72x100	1438
2	Left door jamb - Türrahmen links - Cadre de porte gauche - Telaio montante sinistro della porta - Linkerstijl deurframe - Ukse vasak leng		1	72x80	1850
3	Right door jamb - Türrahmen rechts - Cadre de porte droit - Telaio montante destro della porta - Rechterstijl deurframe - Ukse parem leng		1	72x80	1850
4	Doorstep - Swelle - Barre de seuil - Soglia della porta - Deurdorpel - Lävepakk		1	20x25	1418
5	Connection strip - Deckleiste - Baguette de battement - Profilo verticale della porta - Stulplijst - Kokkuvältsiliist		1	13x32	1812
6	Georgian bars - Sprossen - Croisillons - La griglia georgiana - Raamverdeling - Petteliistud		2	15x25	1527
7	Georgian bars - Sprossen - Croisillons - La griglia georgiana - Raamverdeling - Petteliistud		6	15x25	536



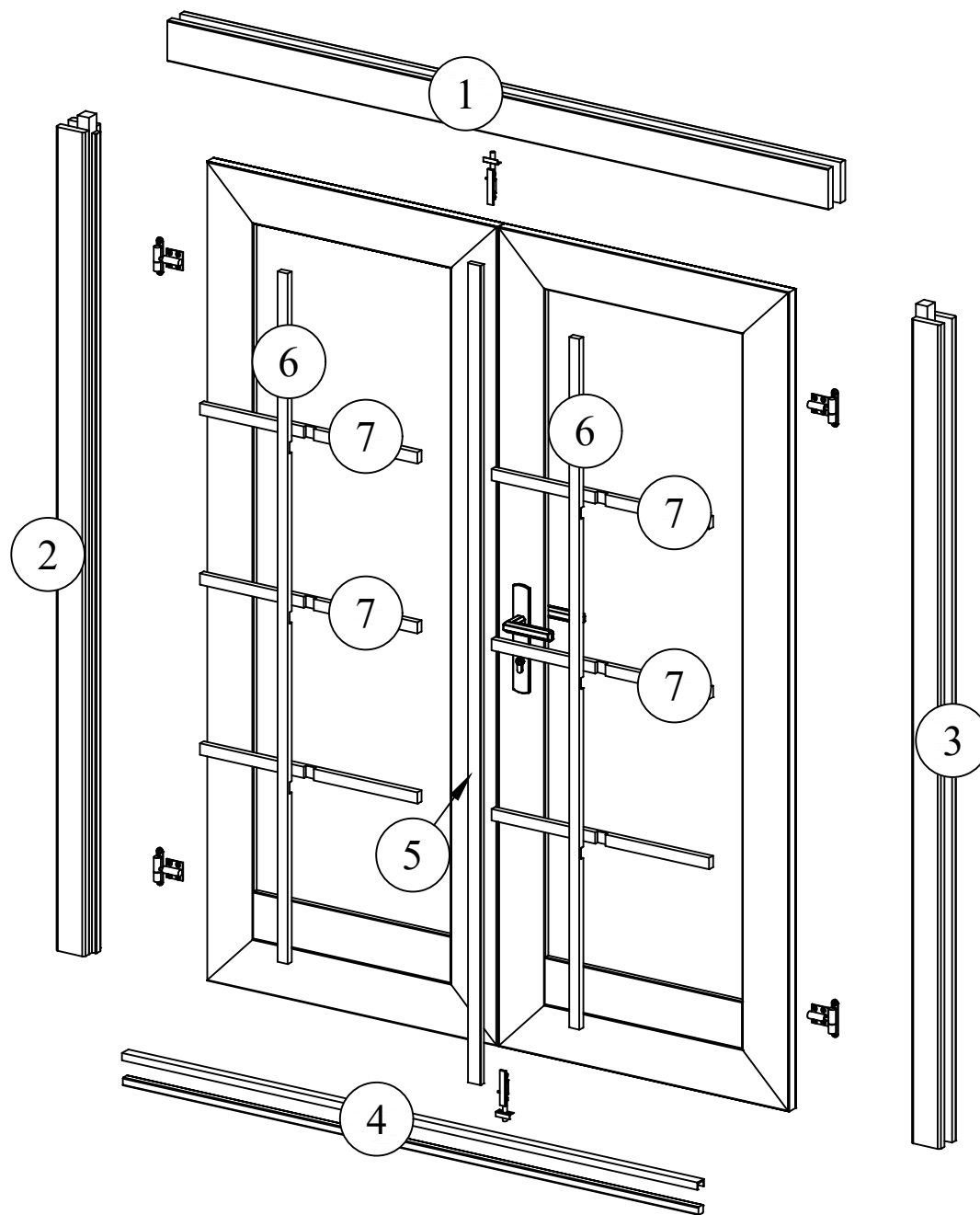



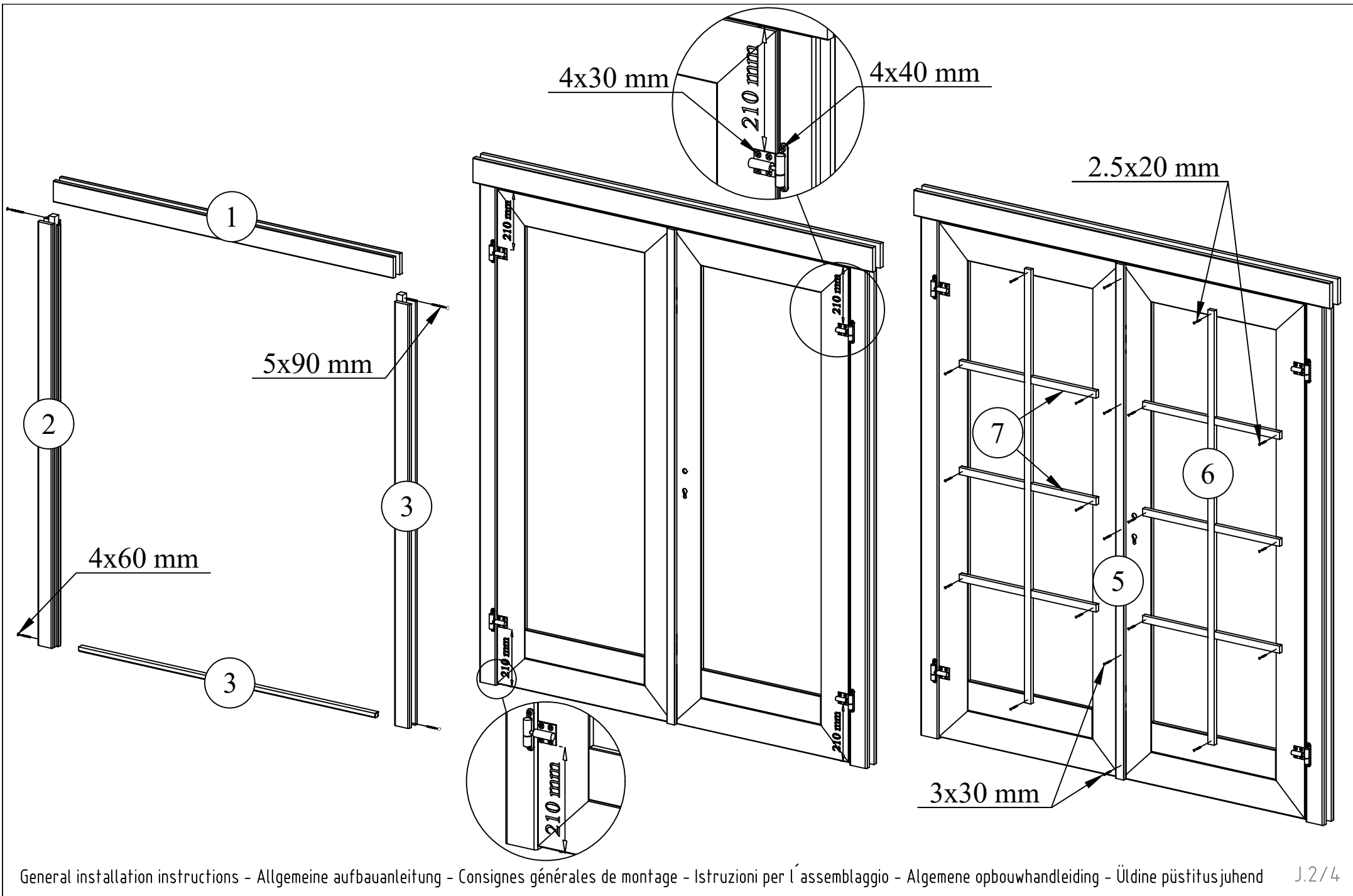

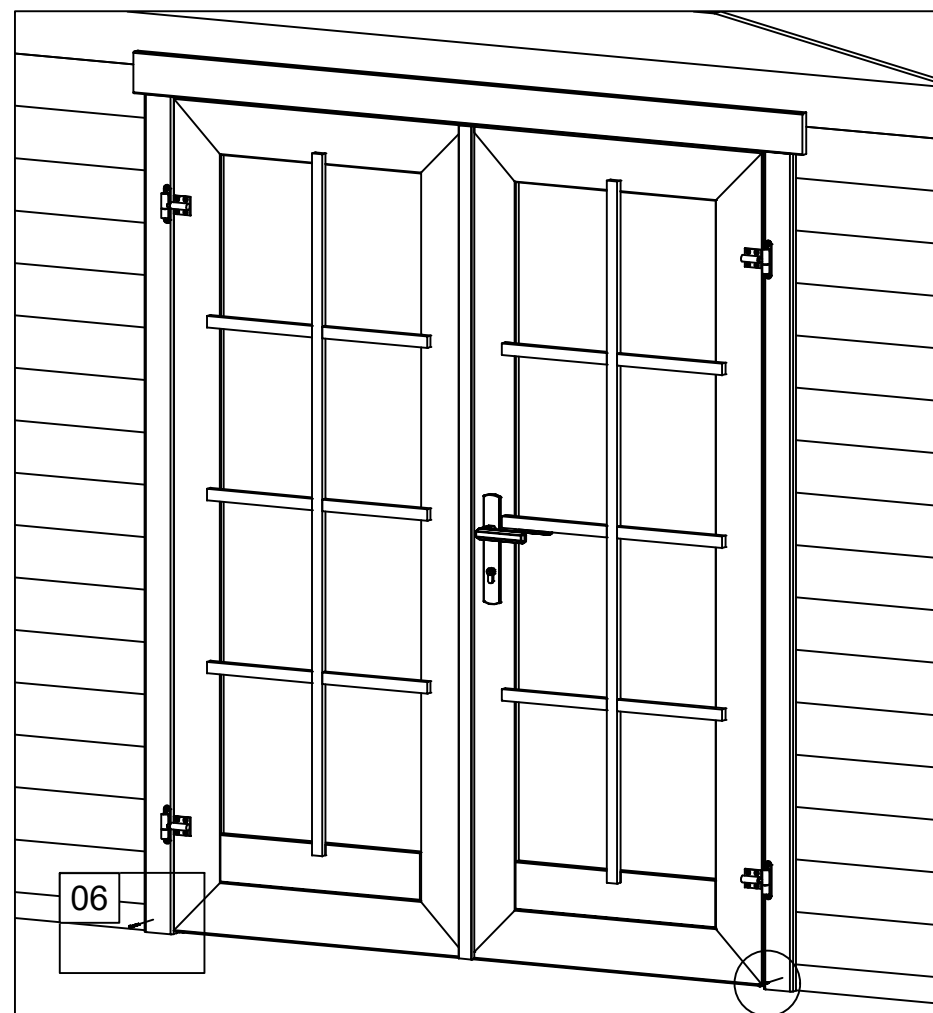
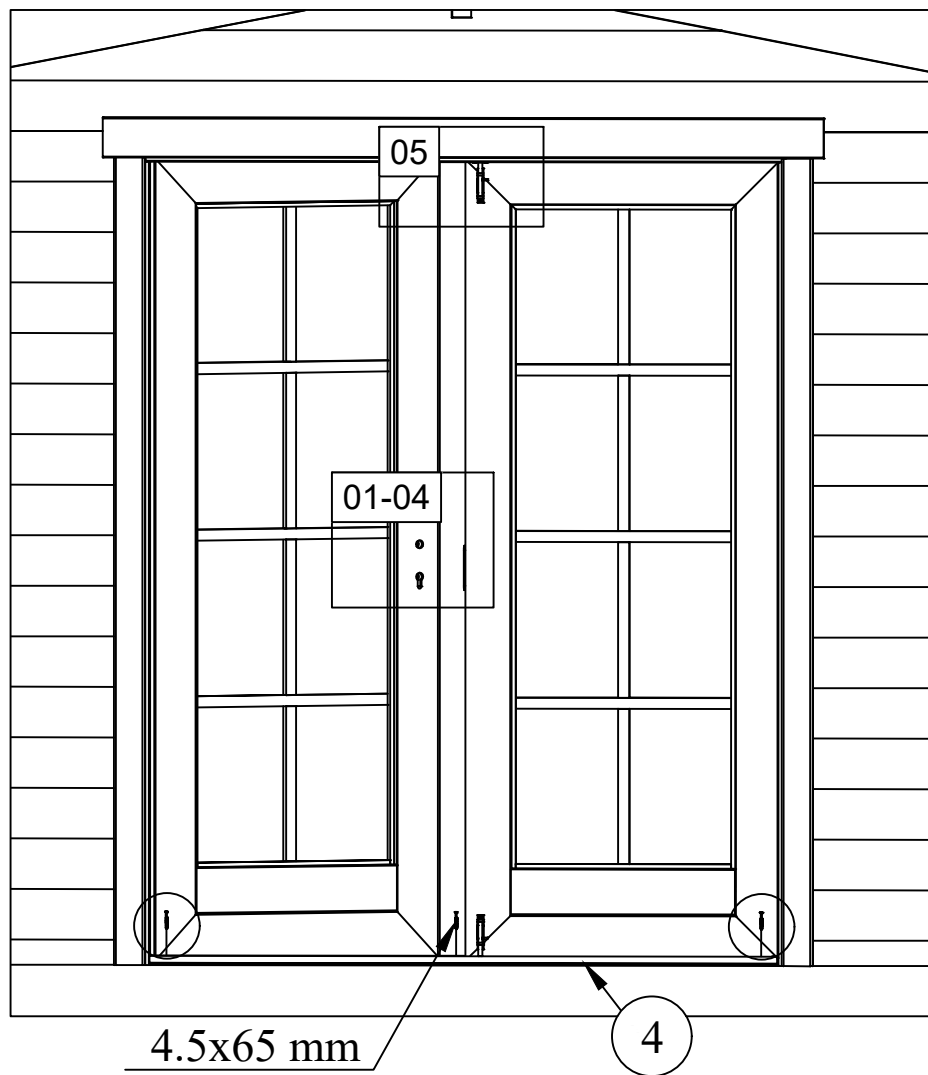

01

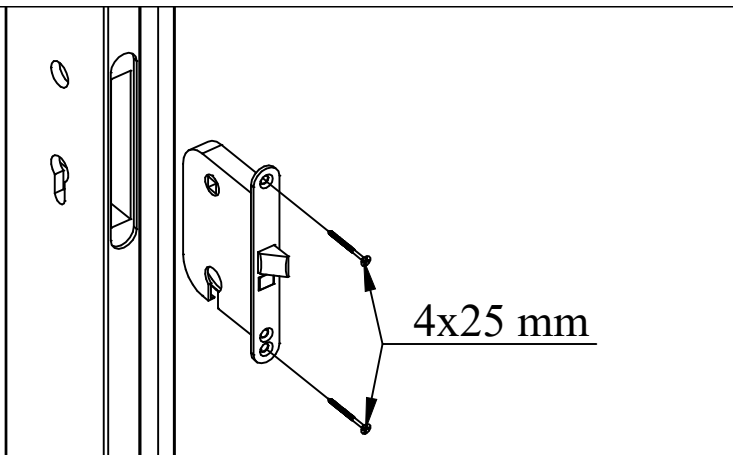

04

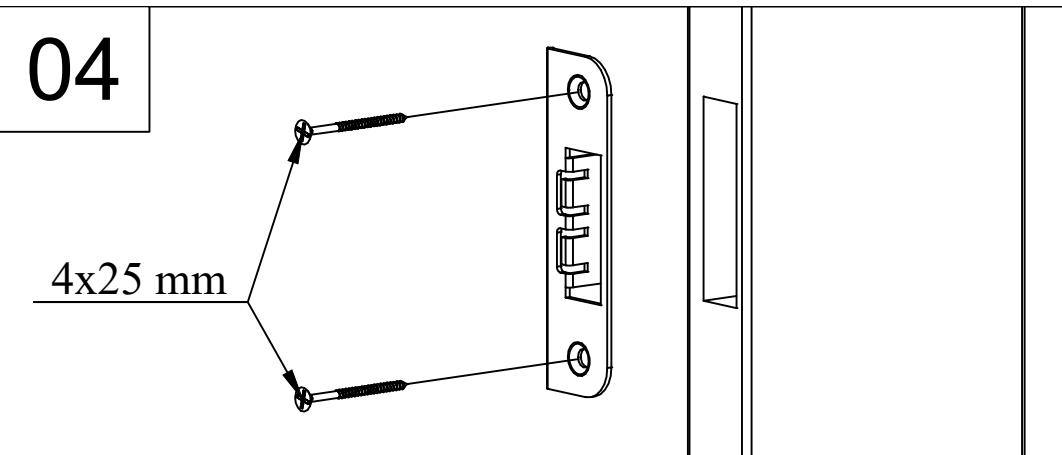

02

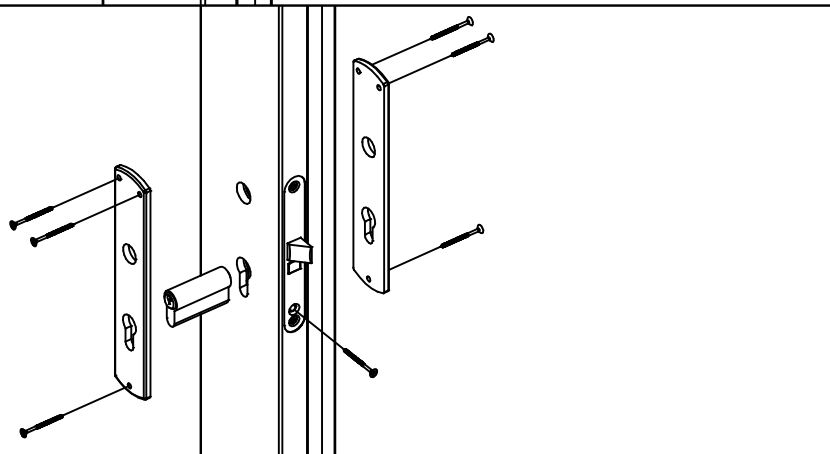

05

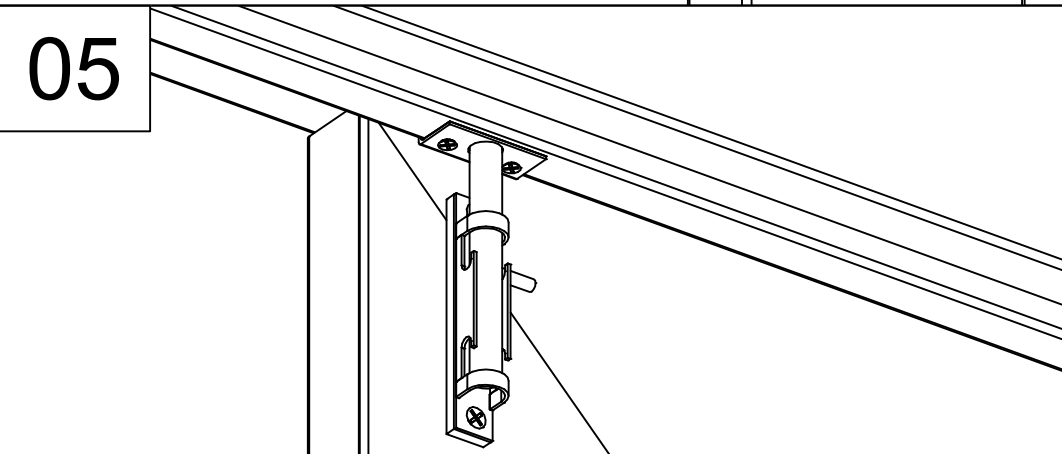

03

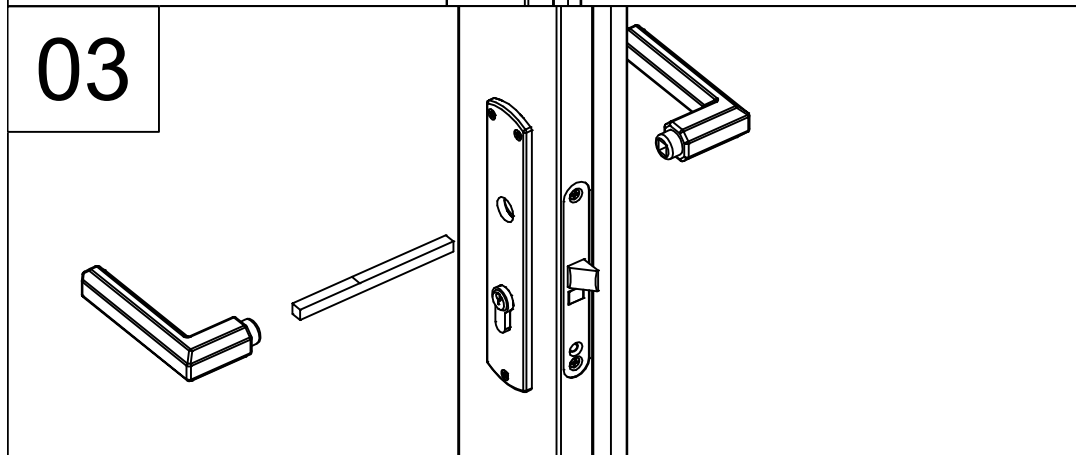

06

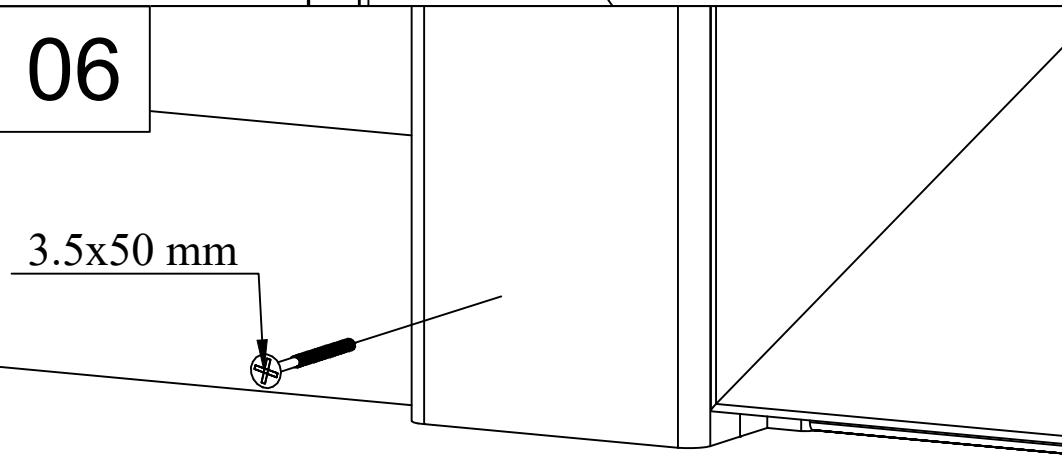

# DANCOVER<sup>®</sup>

.com

## Contact information

Austria



Belgium



Croatia



Denmark



Estonia



Finland



France



Germany



Ireland



Italy



Latvia



Lithuania



Nederland



Norway



Poland



Portugal



Spain



Sweden



Switzerland



UK



For more information please visit: [www.dancovershop.com](http://www.dancovershop.com)